

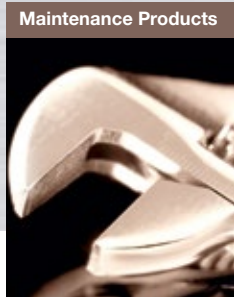

***For a world in motion***

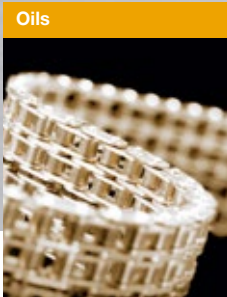
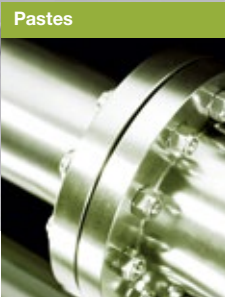

**THE CATALOGUE**

Speciality Lubricants  
Maintenance Products



## 40 YEARS OF TRIBOLOGICAL EXPERTISE – MADE IN GERMANY

### OKS – your professional partner for chemotechnical special products

The OKS brand stands for high-performance products for reducing friction, wear and corrosion. Our products are used in all the areas of production and maintenance technology in which the performance limits of classic lubricants are exceeded.

#### Quality – Made in Germany

The continued success of OKS for more than 40 years is decisively characterised by the high quality and reliability of our products, as well as the fast implementation of customer requirements through innovative solutions.

The products developed by OKS engineers and chemists are produced under strict quality requirements in Maisach near Munich, Germany, our company's headquarters. Worldwide distribution is carried out just-in-time from Maisach, supported by a modern logistics centre.

The long-standing certifications by the TÜV SÜD Management Service GmbH in the fields of quality (ISO 9001: 2008), environment (ISO 14001: 2004) and work protection (OHSAS 18001: 2007) are proof of the high OKS quality standard.



#### A company of the Freudenberg Group

Since 2003 OKS Spezialschmierstoffe GmbH has been part of the international Freudenberg Group, with headquarters in Weinheim, Germany. We utilize the comprehensive know-how and the innovative power of the Freudenberg Chemical Specialities (FCS) division for the further development of new products and markets to ensure the continued dynamic growth of our company in the future.

#### OKS – Partner to Trade

Our speciality lubricants and chemotechnical maintenance products are sold exclusively via the technical and mineral oil trades. The consistent strategy of "sales only via trade", the smooth processing of orders and our comprehensive technical service make us one of the preferred partners for demanding customers worldwide. Use our specialist's know-how. Put us to the test.



SUPPLIER OF THE  
YEAR 2013



- 4\_ Tribology and Lubricant Types**
- 18\_ Testing Procedures and Standards**
- 23\_ Technical Terms**
- 24\_ Mo<sub>x</sub>-Additive Technology**
- 25\_ Speciality Lubricants for Food Processing Technology**
- 26\_ Lubricant Solutions for Critical Application Conditions**
- 27\_ OKS Selection Guide and Selection Tables**
- 38\_ Pastes**
- 44\_ Oils**
- 54\_ Greases**
- 66\_ Dry Lubricants**
- 70\_ Corrosion Protection**
- 72\_ Maintenance Products and Cleaners**
- 78\_ Airspray-System**
- 80\_ ChronoLube-System for Automatic Relubrication**
- 82\_ Lubricating Devices**



We focus on the development of customer-specific lubricant solutions in close cooperation with our trade partners.

Experts from a wide range of different disciplines work in our laboratories with state-of-the-art systems and test equipment to modify existing or develop new products for special application cases.

## Reduction of friction and wear through optimal lubrication

Several billion Euros of economic losses are caused every year through friction and wear. In order to reduce these cost extensive tribological basic research is carried out. On this basis, companies then occupy themselves with specific knowledge, such as OKS Spezialschmierstoffe GmbH with the development of high-performance lubricants.

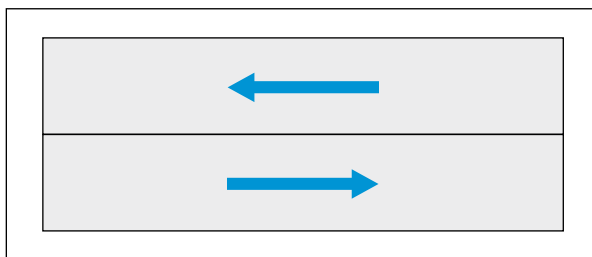

Friction

### What is friction?

Friction is the mechanical resistance to the relative movement of two surfaces. Friction is usually undesirable in technical systems, because it is associated with energy loss, friction heat and wear.

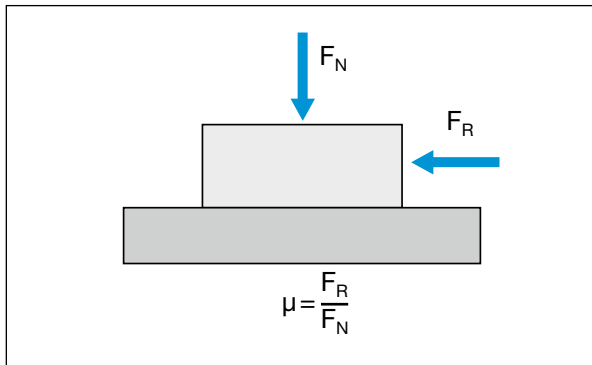

Coefficient of friction

### Determining the coefficient of friction

The following equation is used to determine the friction (to Coulomb).

$$\frac{F_R \text{ (frictional force)}}{F_N \text{ (normal force)}} = \mu \text{ (coefficient of friction)}$$

Friction can be divided into sliding friction, pivoting friction, rolling friction and rolling resistance friction.

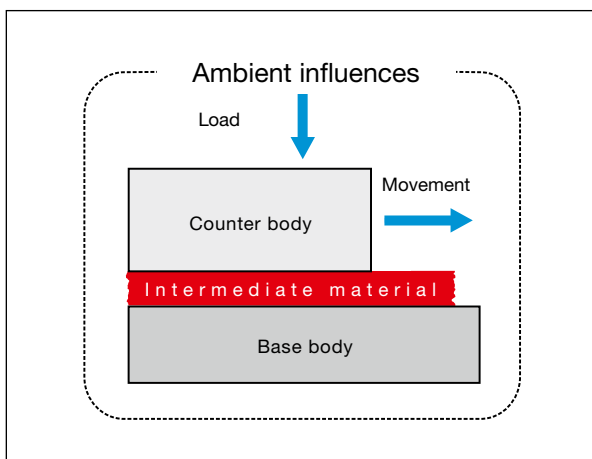

Tribological system

### The tribological system

For an optimal problem solution all the influencing variables in a tribological system have to be known. Allowances have to be made for the complex interactions of these factors. Ambient influences (dust, temperature or moisture) and structural factors (material, surface or geometry of the friction bodies) play just as great a role as stress factors (speed, pressure stress or vibrations) as far as selecting the correct intermediate material (= lubricant) is concerned.

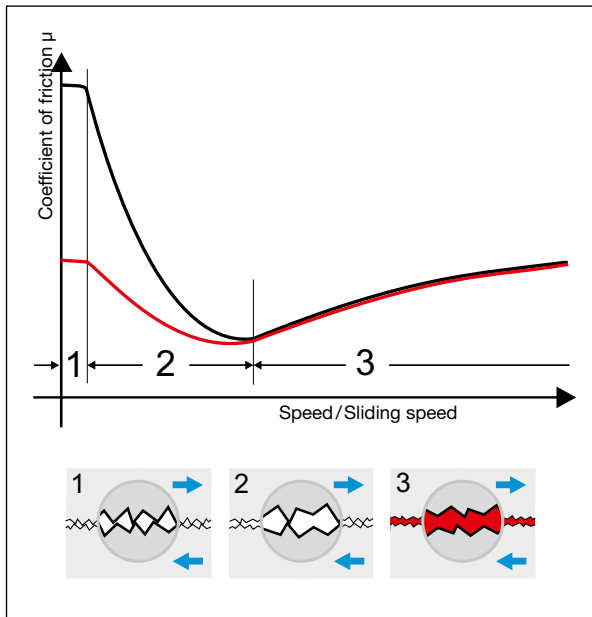

Stribeck curve

### Stribeck curve

The course of the coefficient of friction of a friction bearing with oil or grease lubrication in the various friction and lubrication states can be described using the Stribeck curve as an example.

During the start-up phase the static friction is followed by the solid state friction (high coefficient of friction/high wear). As speed increases a partial separation of the sliding surfaces takes place in the mixed friction phase by the lubricating film (medium coefficient of friction/medium wear). The emergency running film that is formed by solid lubricants protects at exactly this point (see red curve). At high speeds a hydrodynamic liquid film separates the sliding surfaces completely from each other (as at aquaplaning). In this phase of liquid friction the lowest wear and the lowest friction is achieved.

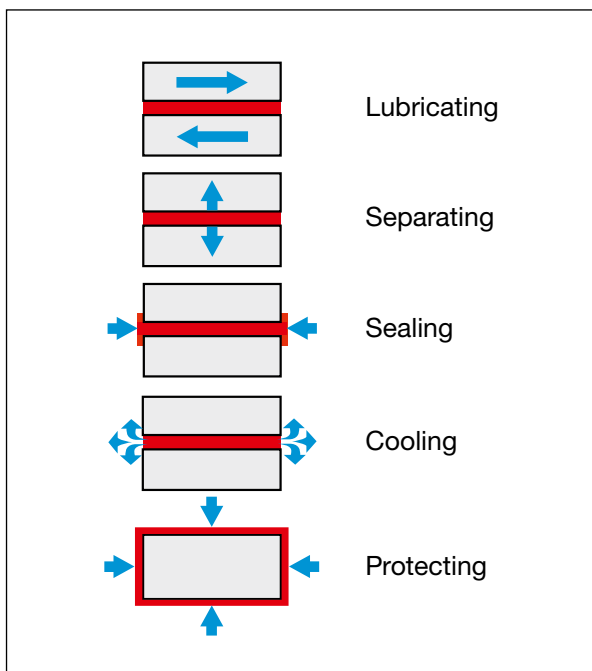

Spectrum of tasks of a lubricant

### Multiple function of the lubricants

The functions of a lubricant can be varied and, depending on the particular application, can be necessary alone or in combination. Besides the primary demand placed on the lubricant – maximum power transfer combined with a minimum of friction and minimum wear – it is often necessary to fulfil various secondary properties such as water resistance, chemical resistance, compatibility with plastics or corrosion protection.

### Oils with high-performance additives for reliable lubrication

Oils dissipate heat well from the lubricating point. In addition, they have a notably good creep and wetting behaviour. Therefore oil lubrication is often used at high temperatures or high speeds of rotation. Typical fields of application are gears, chains, friction bearings, hydraulics and compressors.

#### Characteristics of oils

Characteristic	Standard	Description
Viscosity	DIN 51 562-1	Dimension for the inner friction of liquids
ISO VG	DIN 51 519	Classification of oils into viscosity classes based on DIN 51 561
Operating temperature		Temperature range of the optimal performance
Flashing point	DIN ISO 2592	Lowest temperature at which the vapour-air mixture catches fire through extraneous ignition
Setting point	DIN ISO 3016	The lowest temperature at which the oil is still just capable of flowing

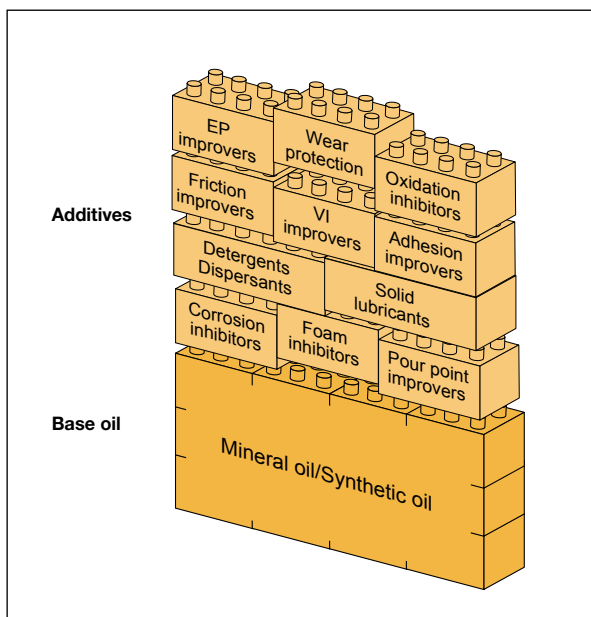

Structure of high-performance oils

#### Structure of high-performance oils

The additives play an important role in the formulation of a high-performance oil in addition to the careful selection of the base oil (type, viscosity) and has considerable influence on the price-performance ratio. Modern lubricating oils are conceived so that when the oil film is breached, the active ingredients form a protective film, so that the surfaces are protected against wear.

## TYPES OF LUBRICANTS

### Properties of base oils

The base oil plays a decisive role in the selection of a lubricating oil. Mineral oils, synthetic hydrocarbons (polyalphaolefines = PAO), ester, polyglycols and silicone oils differ notably in their physical properties and chemical behaviour.

Properties	Mineral oils	Synthetic hydrocarbons (PAO)	ester oils	Polyglycol oils	Silicone oils
Density 20 °C [g/ml] approx.:	0.9	0.85	0.9	0.9 – 1.1	0.9 – 1.05
Setting point [°C] approx.:	-40 → -10	-50 → -30	-70 → -35	-55 → -20	-80 → -30
Flashing point [°C] approx.:	< 250	< 200	200 → 270	150 → 300	150 → 350
Resistance to oxidation	-	+	+	+	++
Thermal stability	-	+	+	+	++
Compatible with plastics	+	+	-	type-dependent	+

### Compatibility of oils

The miscibility of different lubricating oils is influenced considerably by the base oils and has to be observed correspondingly when changing the lubricating oil, under consideration of the viscosity.

	Mineral oil	Polyalphaolefines	ester oils	Polyglycol oil	Silicone oil (methyl)	Silicone oil (phenyl)	Polyphenylether oil	Perfluoropolyether oil
Mineral oil	■	■	■			□		
polyalphaolefines	■	■	■					
ester oils	■	■	■	■		■	■	
Polyglycol oil			■	■				
Silicone oil (methyl)					■	□		
Silicone oil (phenyl)	□		■		□	■	■	
Polyphenylether oil			■			■	■	
perfluoropolyether oil								■

■ miscible □ partially miscible

### Oils with high-performance additives for reliable lubrication

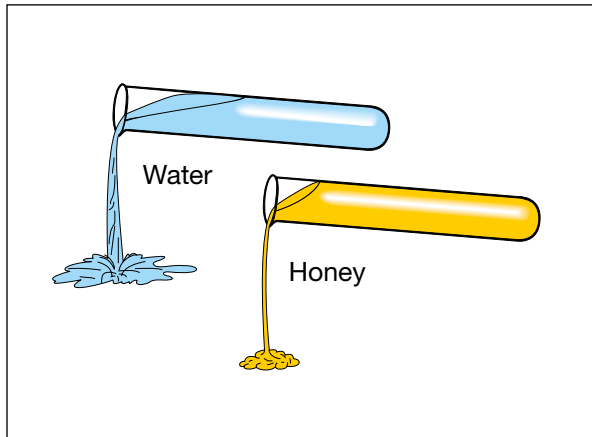

Viscosity

#### Viscosity – the dimension for the inner friction of liquids

The choice of the viscosity of an oil depends on the area in which the lubricant is used. The following basically applies: Low viscosity for low pressure stress and high sliding speeds, high viscosity for high pressure stress, low sliding speeds and high temperatures. The viscosity can be determined with different measuring processes (see Test and measuring processes).

The kinematic viscosity is specified in  $\text{mm}^2/\text{s}$  and is used for classification. The dynamic viscosity is specified in  $\text{mPa s}$ . The two viscosities can be converted into each other under consideration of the density with the equation: Dynamic viscosity = Density x kinematic viscosity.

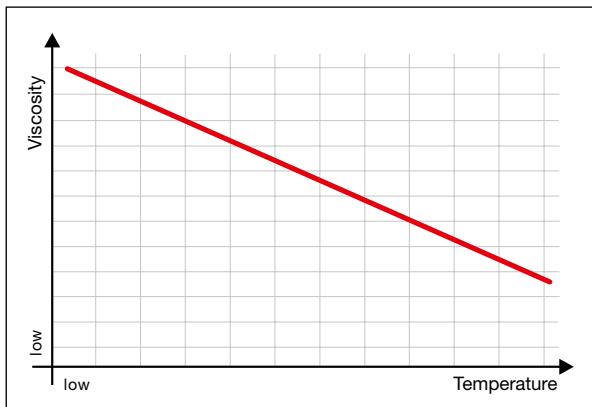

Temperature dependence of the viscosity

#### Dependency of the viscosity from the temperature

The viscosity of an oil depends on the temperature, the pressure and shear stress as well as the time in which it happens. The most important influencing factor is the temperature. As the temperature increases, the viscosity decreases and vice versa, depending on the type of oil.



## TYPES OF LUBRICANTS

The classification of lubricating oils into viscosity classes is effected to ISO (DIN 51519) or SAE (Society of Automotive Engineers).

Kinematic ISO-VG	Viscosity (40 °C) [mm <sup>2</sup> /s]
15	13.5 – 16.5
22	19.8 – 24.2
32	28.8 – 35.2
46	41.4 – 50.6
68	61.2 – 74.8
100	90 – 110
150	135 – 165
220	198 – 242
320	288 – 352
460	414 – 506
680	612 – 748
1,000	900 – 1,000
1,500	1,350 – 1,650

Viscosity classes to DIN 51519

### ISO viscosity classes to DIN 51519

ISO-VG (Viscosity Grade) classes apply only for industrial lubricating oils. There are 18 kinematic VG classes from 2 mm<sup>2</sup>/s to 1,500 mm<sup>2</sup>/s. Determining of the viscosity is carried out at 40 °C.

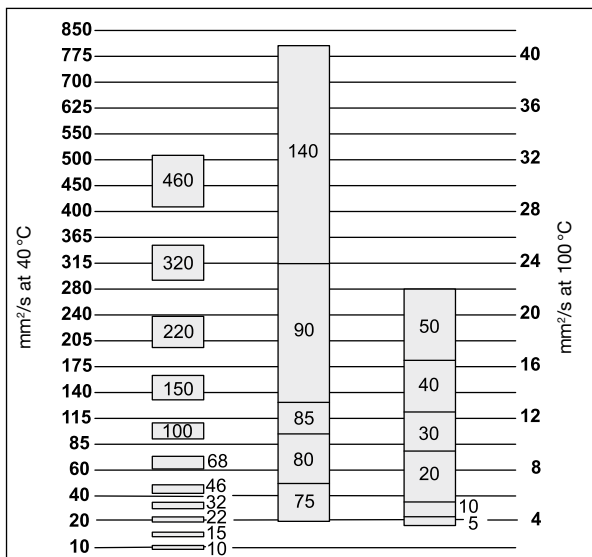

Comparison of the viscosity classes to ISO-VG and SAE

### Viscosity classes to SAE

Lubricating oils for vehicle gears and motors are classified into SAE viscosity classes. These range from 0 – 60 at motor oils and from 70 – 250 at gear oils. The viscosity values are measured at 100 °C.

### Greases for long-term lubrication under critical operation conditions

If, for structural reasons, no oil lubrication is possible or if a cooling function is not required, a lubricating grease is used in most cases. Greases consist of a base oil that is bound by a thickener (soap). This ensures that the lubricant remains at the lubricating point. There it ensures permanently effective protection against friction and wear and seals the lubricating point against external influences such as moisture and foreign matter. Greases are often used at rolling and friction bearings, spindles, fittings, seals, guides, but also at chains and gears.

#### Characteristics of greases

Characteristic	Standard	Description
Base oil viscosity	DIN 51 562-1	Influences the speed range and load capacity of a grease
Drop point	DIN ISO 2176	Exceeding of this temperature results in destruction of the grease structure
Operating temperature	DIN 51 805 – Min DIN 51 821/2 – Max	Temperature range of the optimal performance at roller bearing greases
Speed parameter (DN value)		Maximum rotating speed up to which a grease can be used in a roller bearing
Consistency	DIN ISO 2137	Dimension for the stability of a grease (worked/unworked penetration)
NLGI grade	DIN 51 818	Classification to the consistency classes to DIN ISO 2137
Four-ball test	DIN 51 350	Determining of the wear protection and of the maximum load capacity of a roller bearing grease

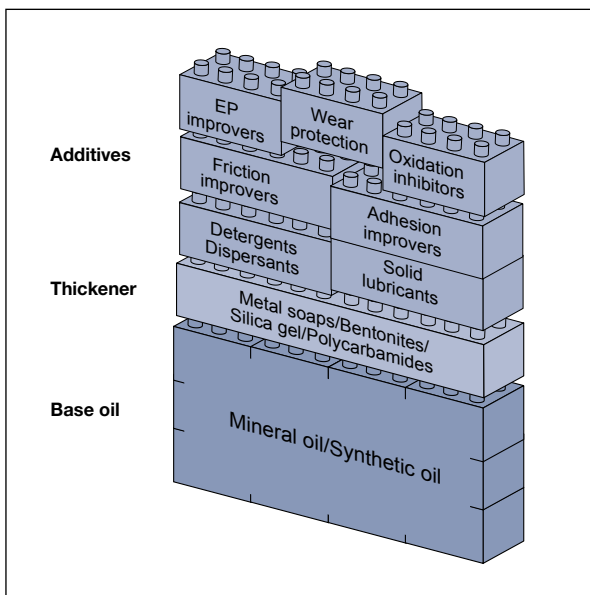

Structure of greases

#### Structure of greases

The main difference in the structure of greases compared to oil is the thickener which determines the typical performance features of a grease.

Modern lubricating greases are formulated so that their active ingredients form an emergency running lubricating film in case of critical stresses and ensure operational reliability.

## TYPES OF LUBRICANTS

### Influence of the thickener on the performance features of a grease

Thickener (soap)	Operating temperature [°C]		Drop point [°C]	Water resistance	Load capacity
	Mineral oil	Synthetic oil			
Calcium	-30 → 50	n.a.	< 100	++	+
Lithium	-35 → 120	-60 → 160	170 / 200	+	-
Al-complex	-30 → 140	-60 → 160	> 230	+	-
Ba-complex	-25 → 140	-60 → 160	> 220	++	++
Ca-complex	-30 → 140	-60 → 160	> 190	++	++
Li-complex	-40 → 140	-60 → 160	> 220	+	-
bentonitee	-40 → 140	-60 → 180	without	+	-
Polycarbamide	-30 → 160	-40 → 160	250	+	-

### Compatibility of greases

In addition to the compatibility of the base oils, the miscibility of the thickeners has to be taken into account when changing greases. An incompatibility has a negative influence on the performance of the lubricating grease.

	Ca-soap	Ca <sub>x</sub> -soap	Li-soap	Li <sub>x</sub> -soap	Li/Ca-soap	Na-soap	bentonitee	Ba <sub>x</sub> -soap	Al <sub>x</sub> -soap	Poly-carbamide
Ca-soap	■	■	■	■	■		■	■		■
Ca <sub>x</sub> -soap	■	■	■	■	■		■	■		■
Li-soap	■	■	■	■	■		■	■		■
Li <sub>x</sub> -soap	■	■	■	■	■			■	■	
Li/Ca-soap	■	■	■	■	■		■	■		■
Na-soap						■	■	■		■
bentonitee	■	■	■		■	■	■	■		■
Ba <sub>x</sub> -soap	■	■	■	■	■	■	■	■	■	■
Al <sub>x</sub> -soap				■				■	■	■
Polycarbamide	■	■	■		■	■	■	■	■	■

■ miscible

## TYPES OF LUBRICANTS

### Greases for long-term lubrication under critical operation conditions

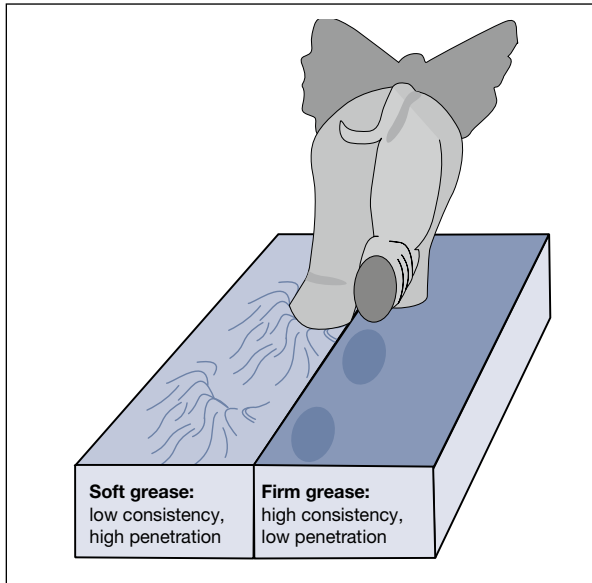

Consistency of a lubricating grease

#### Consistency of a lubricating grease

At lubricating greases the consistency is the characteristic for assessing the strength of a grease. According to DIN ISO 2137 it is measured through the penetration depth of a standardised cone.

#### Classification of greases to NLGI

The classification according to NLGI (DIN 51 818) ranges from very soft (Class 000) to very firm (Class 6). Standard lubricating greases usually comply with NLGI Class 2.

NLGI-class	Worked penetration [mm/10]	Gear lubrication	Friction bearings	Roller bearings	Water pumps	Block greases
000	445 – 475	■				
00	400 – 430	■				
0	355 – 385	■				
1	310 – 340	■	■	■		
2	265 – 295		■	■		
3	220 – 250		■	■		
4	175 – 205			■	■	
5	130 – 160				■	
6	85 – 115 Unworked penetration					■

## TYPES OF LUBRICANTS

### Designation and classification of lubricating greases to DIN 51 502

In view of the multiple possibilities of application and different compositions, lubricating greases are classified and described according to DIN 51 502 by various aspects such as type of lubricating grease, usability, consistency classes (NLGI) and operating temperatures.

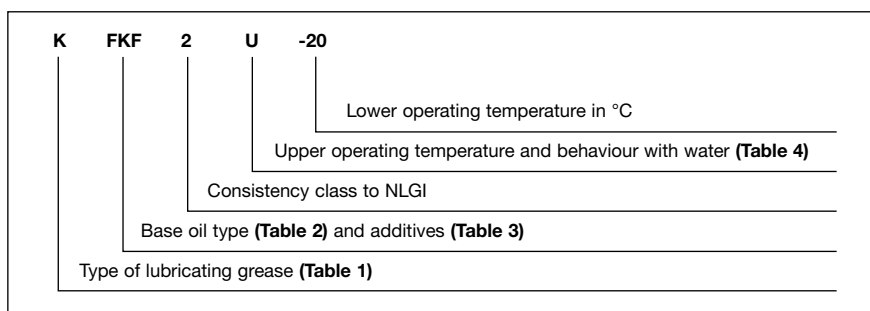

Example of a classification to DIN 51 502

Type of lubricating grease	Identifier
Lubricating greases for roller bearings, friction bearings and sliding surfaces (to DIN 51 825)	K
Lubricating greases for closed gears (to DIN 51 826)	G
Lubricating greases for open gears, toothings (adhesive lubricants without bitumen)	OG
Lubricating greases for friction bearings and seals (lower requirements than at lubricating grease K)	M

Table 1

Base oil type	Identifier
ester oils	E
Fluorinated hydrocarbons	FK
Synthetic hydrocarbons	HC
Polyglycols	PG
Phosphoric acid ester	PH
Silicone oils	Si
Other	X

Table 2

Additive	Identifier
EP additive	P
Solid lubricants (e.g. MoS <sub>2</sub> )	F

Table 3

Identifier	Upper operating temperature [°C]	Behaviour with water to DIN 51 807 Part 1*
C	+60	0 – 40 or 1 – 40
D		2 – 40 or 3 – 40
E	+80	0 – 40 or 1 – 40
F		2 – 40 or 3 – 40
G	+100	0 – 90 or 1 – 90
H		2 – 90 or 3 – 90
K	+120	0 – 90 or 1 – 90
M		2 – 90 or 3 – 90
N	+140	to be agreed
P	+160	
R	+180	
S	+200	
T	+220	
U	above +220	

Table 4

\* 0 = no change  
1 = minor change  
2 = moderate change  
3 = strong change

### Pastes for easy assembly and dismantling

The structure of pastes basically corresponds to that of greases. However, the share of solid lubricants is notably higher. This ensures reliable lubricating, separating and corrosion protection effects also when used under extreme temperature and pressure conditions and aggressive media. Pastes are used at screwed connections as well as when pressing in pins and bolts and furthermore at gearwheels.

#### Characteristics of pastes

Characteristic	Standard	Description
Press-fit test		Provides information about the lubricating effect of pastes at very high pressure and low sliding speed (relevant for assembly pastes)
Thread friction coefficient	DIN EN ISO 16047	The friction coefficient $\mu$ when screws and nuts are tightened is determined on a screw test bench (relevant for screw pastes)
Breakaway torque	DIN 267-27	Ratio of the required breakaway torque when loosening the screwed connection to the tightening torque
Operating temperature		Lubrication: Oil and solid lubricants are effective Separation: After the oil has evaporated, separating effect through solid lubricants

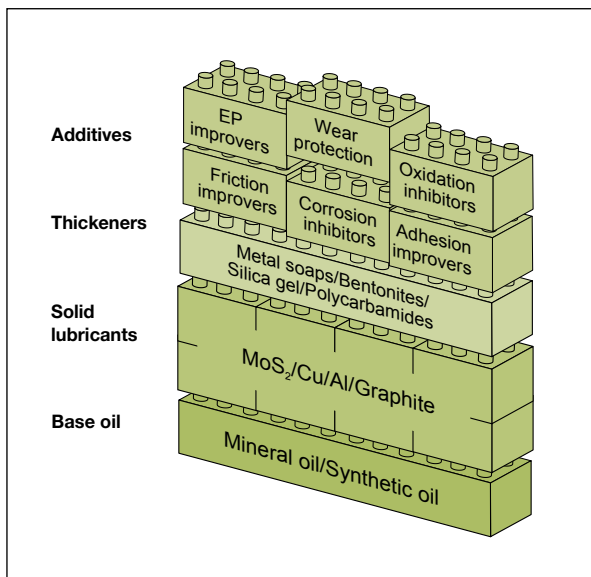

Structure of pastes

#### Structure of pastes

The structure of high-performance pastes is similar to that of greases. The main difference is the high portion of solid component that is typical of both assembly pastes (lubrication effect only) as well as for screw pastes (lubrication and separation effect).

## TYPES OF LUBRICANTS

### Fields of applications of pastes

The field of application of pastes is determined to a great extent by the solid lubricant contained.

Solid lubricant	Maximum operating temperature [°C]	Field of application
PTFE	< 300	Mounting, medium influence
MoS <sub>2</sub>	< 450	Mounting, press-on processes
aluminium	< 1100	High-temperature screwed connections
Copper	< 1100	High-temperature screwed connections, "Anti-Seize" paste, el. conductivity
"Oxide" ceramics	< 1400	Extreme-temperature screwed connections, stainless steel screwed connections



### Dry lubricants – the alternative for special application cases

Dry lubricants can be classified into powdery solid lubricants, ceraceous sliding films and solid-content bonded coatings.

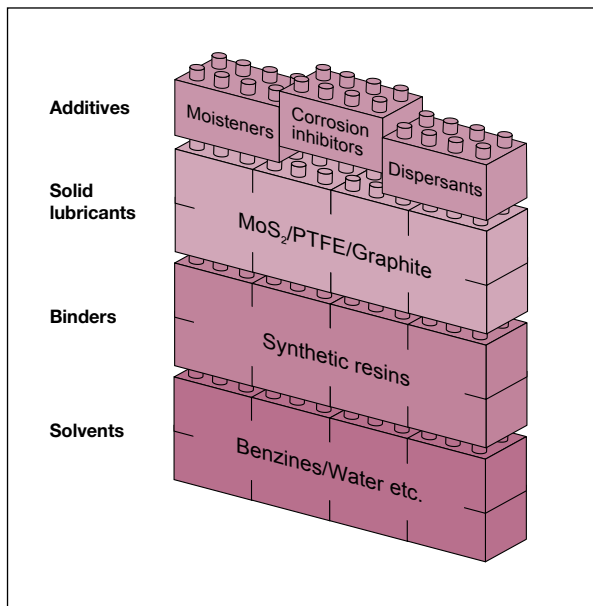

Structure of bonded coatings

Coating with a bonded coating is carried out after thorough preparation of the surface through immersion, spraying or painting. The dry bonded coating layer is between 10 and 20  $\mu\text{m}$  thick. It withstands high pressure loads and extreme temperatures, does not take up soiling and is characterised by very high chemical stability and an excellent long-lasting lubrication.

Bonded coatings are used in many technical fields, e.g. for nuts, screws, bolts, washers, springs, sealing rings, gearwheels, slideways and threaded spindles.

#### Structure of bonded coatings

Bonded coatings are solid lubricants (usually MoS<sub>2</sub>, graphite or PTFE) that are embedded in a binder. A solvent that evaporates during the curing or drying time is added for the distribution of the bonded coating.

In comparison to classical lubricants bonded coatings are characterised by

- Dry lubrication without oil and grease
- Clean lubrication without dirt adhesion
- Very low friction values can be achieved
- High temperature resistance
- No evaporation losses
- Use in vacuum possible
- Chemical-physical stability
- Effectiveness also at low sliding speeds
- Long-term and lifetime lubrication
- High cost efficiency



## TYPES OF LUBRICANTS

### Classification of solid lubricants

Solid lubricants are used as fine powder and can be divided by their structure, as well as into chemically and physically active substances. The most common ones are listed here.

	MoS <sub>2</sub>	Graphite	Tri-calcium-phosphate	Zinc-pyro-phosphate	Calcium hydroxide	Aluminium	Zinc sulphide	Zinc oxide	Calcium fluoride	PTFE	PE
<b>Structure-effective</b> with layer lattice structure	■	■									
<b>Chemically effective</b> with layer lattice structure	■										
<b>Chemically effective</b> without layer lattice structure			■	■	■						
<b>Physically effective</b> with layer lattice structure						■	■	■	■		
<b>Physically effective</b> without layer lattice structure										■	■

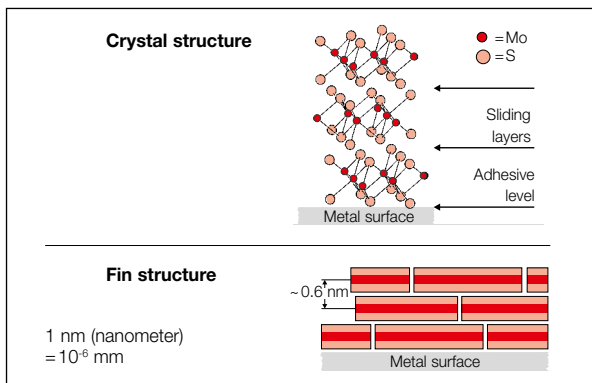

Lubrication by MoS<sub>2</sub>

### Molybdenum disulphide MoS<sub>2</sub>

The best lubrication properties at metal pairs are achieved with MoS<sub>2</sub> (molybdenum disulphide). The layer lattice structure and the chemically effective properties on the metal surface produce low friction, high pressure absorption capacity and an excellent wear protection. Even thin films produce an extremely stable layer in which the MoS<sub>2</sub> fins slide to each other like a pack of cards.

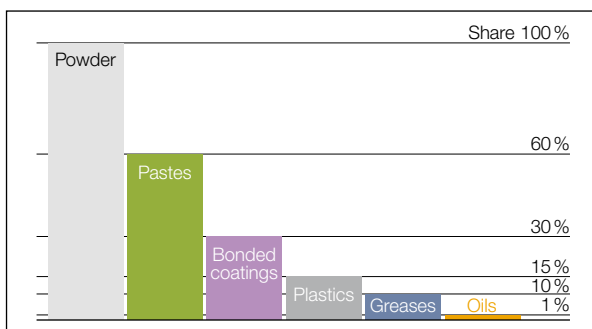

Share of solid lubricants

### Maximum share of solid lubricants in lubricant systems

# OKS lubricants – highest performance for maximum process reliability

Numerous test methods are used to examine and evaluate the various influencing variables of a tribological system for the development and quality assurance of lubricants. The collected characteristics describe the chemical/physical properties of a lubricant which allow statements about its possible suitability for a specific application.

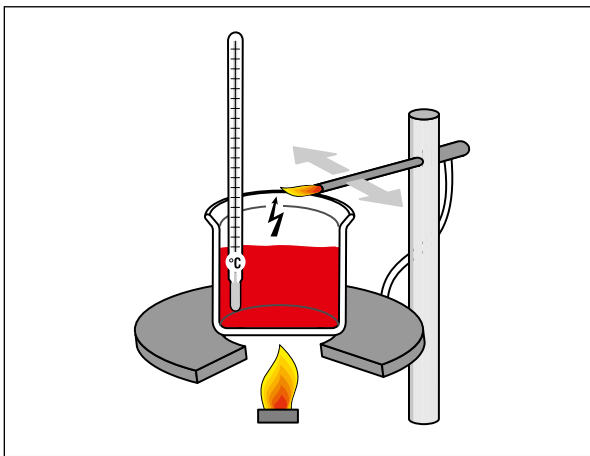

Determining the flashing point

### Flashing point

The flashing point is a measurand at combustible liquids which allows the danger of fire to be assessed. Depending on the product type and height of the flashing point to be expected the most common measuring methods are closed crucibles (to DIN 51755) or open crucibles (to DIN ISO 2592).

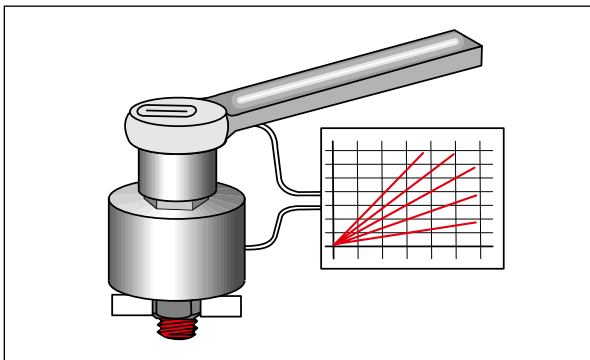

Measuring the thread friction

### Thread friction

The thread friction is determined on a screw test bench. According to DIN EN ISO 16047 the coefficient of friction  $\mu$  of a screwed connection is obtained when screws and nuts are tightened. Thread dimension, materials and type of the surface have to be specified.

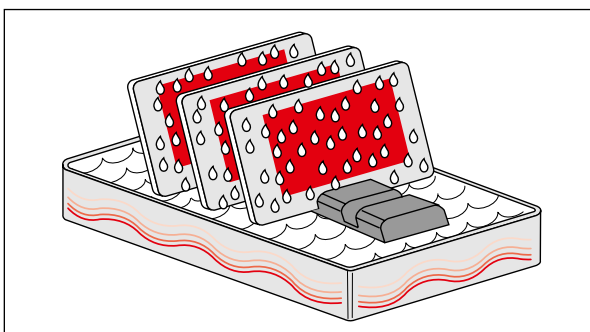

Condensed water test

### Condensed water test

The condensed water test is one of several examinations carried out to assess a protective layer as corrosive influences (DIN 50017 – KTW condense water temperature alternating climate) and defines the test procedure in a climatic chamber at alternating climate. The result is the number of hours until traces of rust arise.

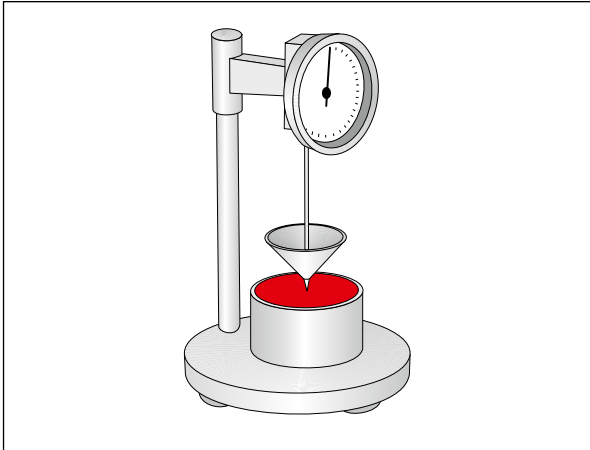

Measuring the consistency

### Consistency

The consistency of a lubricating grease is measured with a penetrometer to DIN ISO 2137 whereby the grease is worked before measuring in order to imitate the stress in a bearing. The penetration depth of a cone allows the allocation to a consistency class to NLGI (DIN 51 818).

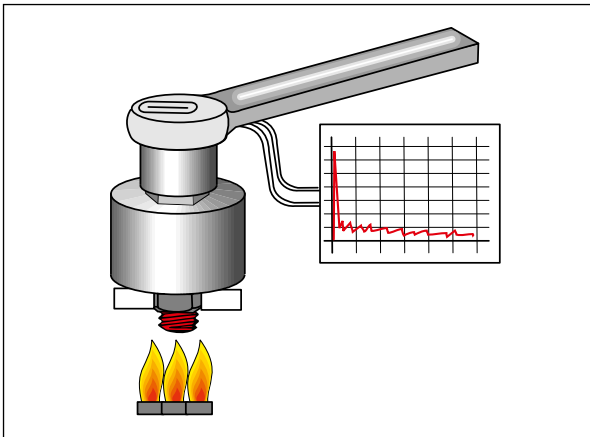

Determining the breakaway behaviour

### Breakaway behaviour

Breakaway behaviour, the ratio of the loosening torque to tightening torque, is determined for high-temperature screw pastes after screws M10 (or M12), material A2-70, have been tightened with 40 Nm (or 70 Nm) and have been subjected to a temperature between +200 °C and +650 °C for 100 hours.

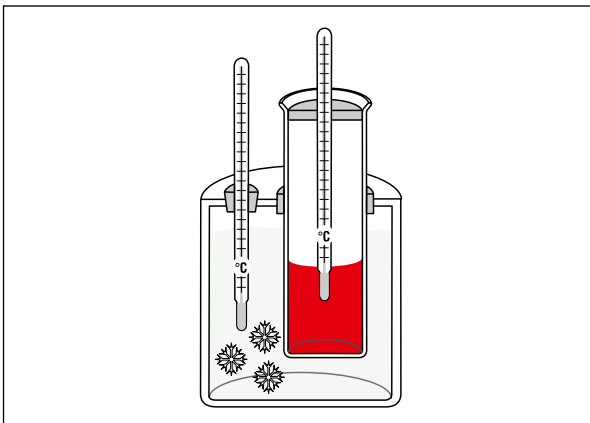

Determining the pour point

### Pour point

The pour point of an oil is measured to DIN ISO 3016. It lies some °C under the recommended lowest operating temperature.

### OKS lubricants – highest performance for maximum process reliability

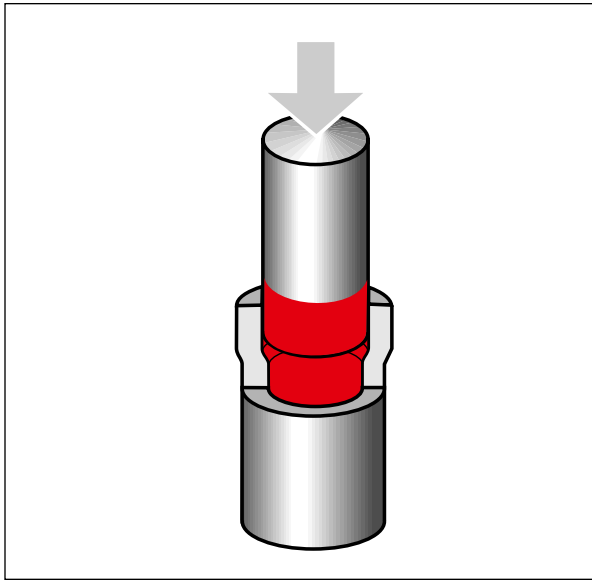

Press-fit-test

#### Press-fit-test

The Press-fit test provides information on the behaviour and the adhesion of solid lubricants under very high pressure and low sliding speeds. The coefficient of friction  $\mu$  is measured and noted whether stick-slipping occurs. Both results are important for the applications during mounting work (e.g. press manufacture) or at sideways and guides (e.g. machine tools).

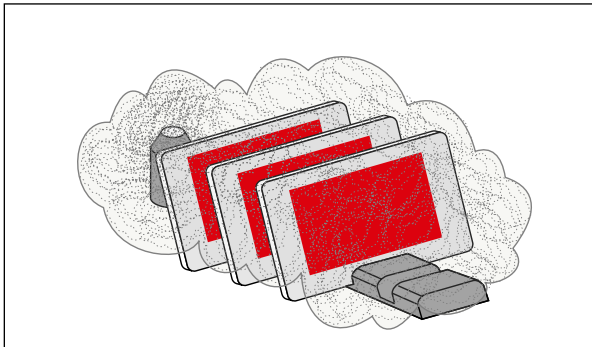

Salt spray test

#### Salt spray test

The salt spray test simulates a salty climate to DIN EN ISO 9227 NSS (ex DIN 50021 SS), whereby coated plates are subjected to a defined salt spray. A check is carried out after how many hours traces of rust arise.

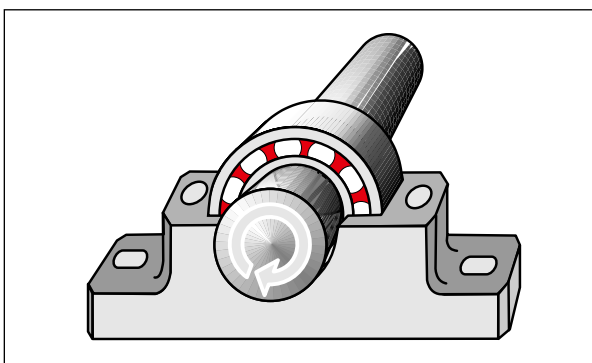

SKF-EMCOR process

#### SKF-EMCOR process

This process is used to assess corrosion-preventive properties of roller bearing lubricants. In the process water is added to the grease and examined for corrosion self-aligning ball bearings with defined running duration, speed and specified standstill periods to DIN 51 802. If there is no corrosion at the visible inspection of the test rings, the degree of corrosion is 0. At very strong corrosion the maximum note is 5.

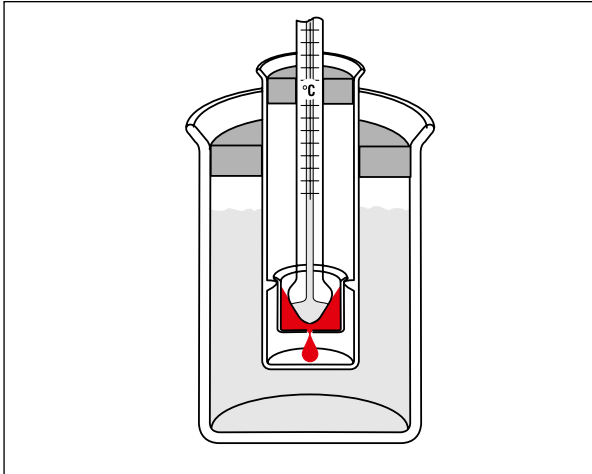

Measuring the drop point

### Drop point

The drop point (in °C) is the temperature of a lubricating grease at which liquefaction occurs, measured to DIN ISO 2176. The drop point lies notably over the recommended upper limit of the operating temperature. However, certain grease thickeners do not liquefy, meaning that they are without a drop point.

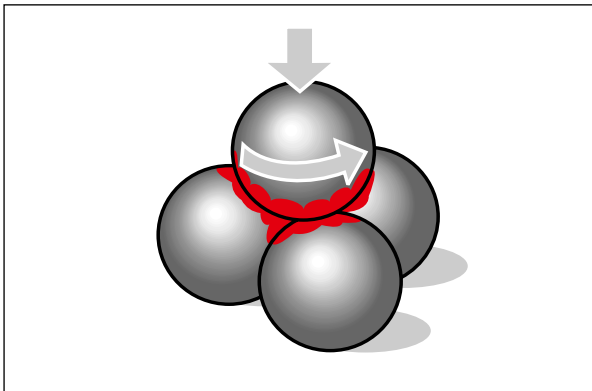

Four-ball test rig

### Four-ball test rig

The four-ball test rig is a testing device for lubricants used at high surface pressures in the mixed friction range. According to DIN 51350, the four-ball test rig consists of a rotating moving ball which slides on three fixed balls. During the test for the maximum load-bearing capacity of the lubricant, a test force acts on the moving ball, which is increased in steps until the four-ball system is welded together as a result of the friction heat produced. In another four-ball test method the wear value of a lubricant is determined under defined test conditions (test force, speed, time).

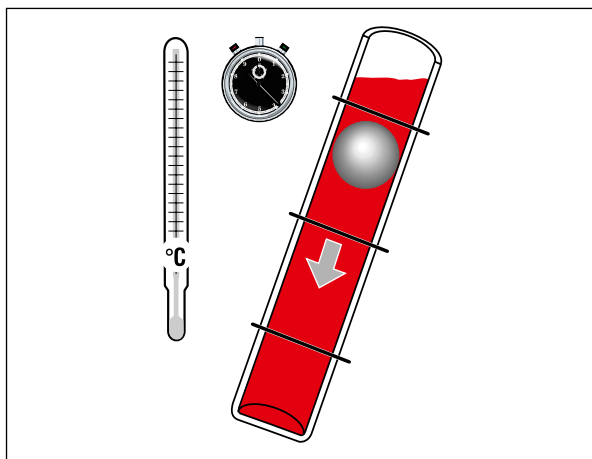

Measuring the viscosity

### Viscosity

The viscosity of an oil is determined with different measuring instruments depending on the type of product. A falling-ball viscometer is used to fulfil the specifications to DIN 51562-1 or similar methods. The specification of the kinematic viscosity  $V$  (ny) [mm<sup>2</sup>/s] is effected at +40°C. The value, for example at +100°C, is often also of interest, so that the drop in the viscosity at higher temperatures can also be assessed.

## OKS lubricants – highest performance for maximum process reliability

### **DN factor**

The DN factor or rotating speed factor is a guide value up to which rotating speeds lubricants can be used in roller bearings.

### **Evaporation loss**

The evaporation loss is of interest particularly at high-temperature lubricants. According to DIN 58397 it is examined at high temperatures for a specified period. The loss of evaporated oil as a % by weight should be as low as possible.

### **FZG torque change test device**

With the FZG torque change test device oils and greases are examined in particular with regard to their suitability as lubricants in closed gears. The wear is determined after every load level and the so-called “damage load level” specified as the result. The test method is described in DIN 51354.

### **Layer thickness (corrosion protection)**

The layer thickness has a decisive influence on the duration of the corrosion protection. To this purpose various measuring methods are used which specify the layer thickness in  $\mu\text{m}$ , depending on the type of protective layer.

### **Lubrimeter test**

The Lubrimeter test is a test device with which the coefficient of friction, wear and operating temperature of lubricants is measured for a specific period at changing loads and sliding speeds with different materials.

### **Oil separation**

The oil separation is measured to DIN 51817 as a % by weight. In the process pressure and temperature is applied to the lubricating grease to be tested.

### **Resistance to oxidation**

The resistance to oxidation is a measure for the resistance against reactions with pure oxygen. According to DIN 51808 the grease is subjected to increased pressure together with the oxygen for a specific period (e.g. 100 hours) and temperature (e.g.  $+99^\circ\text{C}$  or  $+160^\circ\text{C}$ ). The test result is the drop in pressure of the oxygen in Pa (Pascal) as a measure for the degree of oxidation.



**Ageing**

Chemical changes to material through the influence of heat, light and oxygen across the operating time

**Corrosion**

Reaction of a metal with its environment which results in a change and impairment of the function of a component

**DVGW**

**D**eutscher **V**erein des **G**as- und **W**asserfaches  
(German Technical and Scientific Association for Gas and Water)

**Emergency lubrication**

Is achieved through solid lubricants when insufficient lubrication occurs at grease or oil lubricants

**EP additives**

Lubricants with **E**xtr**E**m**E** **P**ressure additives in order increase the pressure resistance and the wear protection properties

**Frictional corrosion**

Corrosion that occurs at fits that are subjected to vibrations with micro frictional movements.  
Immediate rust formation at abrasive particles of steel

**ISO**

**I**nternational **S**tandardization **O**rganisation

**KTW**

Approval for plastics in the drinking water sector

**LGA**

Landesgewerbeanstalt Nürnberg with its institute for food chemistry

**Silicone oils**

Are produced through synthetic processes. They have particularly good viscosity temperature characteristics, are resistant at low and high temperatures and against ageing. Excellent separating properties. Outstanding lubricant for plastics and elastomers. Designations such as polydimethylsiloxane or polyphenylmethylsiloxane specify the special structure of the molecule groups

**Solvent**

Liquids that dissolve other materials without chemical changes

**Stick-slipping**

Occurs at slow movements and insufficient separating effect of the lubricant, since the initial friction is higher than the movement friction

**Synthetic oils**

Produced through chemical processes in contrast to oils from Nature – mineral oils, vegetable oils and animal oils. Allowing certain advantages to be achieved, such as low tendency to coking, low pour point, good resistance to chemicals and often excellent viscosity temperature characteristics. Synthetic hydrocarbons, ester, polyglycols, fluorinated oils and silicone oils are used e.g. for lubricants

**VCI**

**V**olatile **C**orrosion **I**nhibitor is an environmentally friendly corrosion protection additive

**Wear**

Arises when the lubricating film is breached, so that the sliding partners come into contact and rub against each other

**White oil**

Paraffinic mineral oil, highly refined, to remove instable components. White oils are used, for example, in lubricants for medical applications

## INCREASE IN PERFORMANCE THROUGH ADDITIVES

### Intelligent additive technology with Mo<sub>x</sub>-Active: Reducing cost and environmental impact

The task of the additives is to optimise lubricants for the respective application with regard to corrosion and wear protection, emergency running properties, oxidation stability, temperature characteristics and wetting behaviour. The careful selection and the intelligent combination of the additives guarantee the high performance of OKS speciality lubricants.

#### Mo<sub>x</sub>-Active additive

OKS speciality lubricants with the Mo<sub>x</sub>-Active additive technology developed by OKS contain molybdenum complex compounds for increased performance.



#### Effect on the surface

Lubricants with Mo<sub>x</sub>-Active are responsible for the smoothing of the metal surfaces at the lubricating points. Intelligent additives support and accelerate the flow smoothing process on the otherwise rough surfaces and effect a tribological surface coating. The run-in times can be shortened considerably.

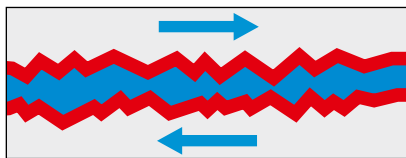

#### Phase 1

Mo<sub>x</sub>-Active is deposited under pressure at the stressed metal surface of the lubricating point.

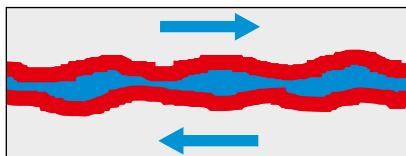

#### Phase 2

As the stress increases, a pressure-stable and effective lubricating protective layer is formed and increases the pressure absorption capacity. Friction and wear are reduced considerably.

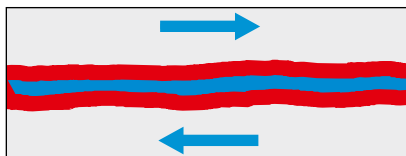

#### Phase 3

Mo<sub>x</sub>-Active supports and accelerates the flow smoothing process of the metal surface. Best results are achieved here in combination with MoS<sub>2</sub>. This structural change produces a tribological surface coating with extremely low coefficient of friction and high wear protection.

#### Cost reduction and reduction of environmental impact

OKS speciality lubricants with Mo<sub>x</sub>-Active reduce the operating costs, increase the quality in production and reduce the environmental impact through lower lubricant consumption and lower energy requirements.



## **SPECIALITY LUBRICANTS FOR FOOD PROCESSING TECHNOLOGY**

### NSF certified lubricants for safe food processing and production

**OKS speciality lubricants for food processing technology can be used in all areas in which human beings could come into contact with lubricants. Application of these lubricants is not limited to the food processing industry. Typical users are amongst others manufacturers of food packaging, machine and system builders for the food processing industry, producers of domestic appliances as well as the toy and pharmaceutical industries.**

#### **With OKS speciality lubricants on the safe side**

There is currently no binding European or international legislation for lubricants approved for use in the food processing industry. As a result, in food processing technology and related areas, it is primarily the US regulations, which are the world's strictest, that are utilised.

#### **Positive list of the FDA**

This list of the FDA (Food and Drug Administration) that is recognised around the world contains all ingredients permissible in lubricants approved for use in food processing. All lubricants tested by the NSF (National Sanitation Foundation) are published in the white book of the NSF based on this list. You can find the list of these lubricants at [www.nsf.org](http://www.nsf.org) in the chapter entitled "Nonfood Compounds Listings Directory", arranged by company name.

#### **NSF classification**

The classification NSF H1 stands for lubricants which may be used when contact with food cannot be excluded in the event of failure.

The lubricants that may be used when contact with food is technically excluded are summarised under NSF H2.



#### **EC Directive 93/43/EEC (issued 14/6/93)**

This directive requires food processing plants to use the HACCP (Hazard Analysis Critical Control Point) method. This preventative system ensures that every contamination-relevant step in the manufacturing process of a food processing and production can be identified and monitored. Even if this directive contains no regulations with regard to the ingredients of lubricants approved for use in food processing, the HACCP method describes the use of lubricants in food processing technology.



**By using OKS speciality lubricants for food processing technology, you ensure compliance with national and international regulations – because of your responsibility to people.**

## LUBRICANT SOLUTIONS FOR CRITICAL APPLICATION CONDITIONS

### OKS experts stand for innovative ideas and product concepts

**Movement without friction is a dream of mankind. But friction still remains a fact of life. To ensure “frictionless” running of your machines, OKS can provide a lubricant solution for almost any application. Whether the lubrication of roller bearings, chains or slideways, under extreme conditions of use or under the influence of aggressive media – with lubricants from OKS you solve your tribological problems safely and reliably.**

#### Extreme conditions of use

Ever more productive machines, combined with extended operating lives push materials and machine elements to their stress limits. OKS offers lubricants that unfold their full performance even under these conditions. Various OKS speciality lubricants resist extreme temperatures, high temperature fluctuations or high pressures.

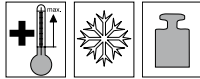

#### Plastic lubrication

New design developments mean that friction pairs are increasingly being used that place particular requirements of the compatibility of the lubricants. Special alloys or ceramic elements are used. Material combinations of plastic/metal and plastic/plastic are increasingly also being used. OKS provides lubricants that are compatible with many materials.







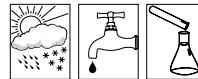





































#### Lubrication under the influence of aggressive media

Whether in permanent use with contact to acids or lyes at columns, boilers or pipings in process engineering industries, at corrosive influences, at outdoor weathering or under the influence of salt water, your plants remain completely operational also under these conditions thanks to OKS speciality lubricants.

















# OKS SELECTION GUIDE















## Fields of Application

	Roller bearings		Valves		Measuring devices		Dust removal
	Friction bearings		Press fittings		Precision mechanics		Leak detection
	Chains		Moulding		Hinges		Belt drives
	Pivoting bearings		Splined shafts		Wire cables		Offshore
	Levers		Camshafts		Hydraulics		Storage/Shipping
	Slideways		Springs		Compressors		Steel construction
	Linear guide systems		Brakes		Separating - mould release		Sheet-metal processing
	Spindles		Open gears		Separating - weld release		Rust remover
	Threaded connections		Closed gears		Cleaning		Foam cleaning
	Chucks		Worm gears		Electrical contacts		
	Seals		Cutting tools		Cooling		

















## Properties

	High temperatures		Effects of water		Environmentally friendly
	Low temperatures		Effect of chemicals		Foam forming
	High speeds		Corrosion protection		NSF certified
	Heavy loading		Compatible with plastics		Sprayable with Airspray-System
	Effects of weathering		Long-acting		Electrical engineering/ Electronics















## SELECTION TABLE PASTES

OKS No.														
<b>Pastes</b>														
200				●										
217	●			●										
220/221				●										
230	●			●										
235/2351	●													
240/241	●													
245	●				●		●							
250/2501	●			●	●						●			
252	●			●	●						●			
260														
265				●			●	●						
270				●			●							
277/2771				●	●	●	●			●				
280	●													
1103	●	●						●					●	
1105						●			●	●			●	

To provide a better overview only the main applications are listed.

																	<b>OKS No.</b>	
	•		•	•	•	•				•	•							<b>200</b>
							•		•									<b>217</b>
	•		•	•	•	•				•	•							<b>220/221</b>
				•	•	•			•									<b>230</b>
							•		•									<b>235/2351</b>
							•		•									<b>240/241</b>
							•											<b>245</b>
	•			•			•			•								<b>250/2501</b>
			•	•			•											<b>252</b>
			•	•	•	•	•			•								<b>260</b>
				•		•		•										<b>265</b>
	•		•	•	•	•											•	<b>270</b>
	•		•		•	•			•									<b>277/2771</b>
					•													<b>280</b>
																		<b>1103</b>
																		<b>1105</b>

**SELECTION TABLE OILS**

OKS No.														
<b>Oils</b>														
30				•										
300				•										
310	•			•										
340/341	•		•		•	•	•							
350	•			•										
352/3521	•			•			•							
353	•			•			•							
354/3541	•			•		•	•							
360					•	•			•		•			
370/371					•		•				•			•
387	•			•							•			
390/391														•
600/601					•	•	•		•					•
631				•		•								
640/641		•			•									•
670/671				•		•								
700/701		•			•		•							•
1000	•	•								•				
3520	•			•			•							
3570/3571	•					•					•			
3601					•	•			•		•			
3710		•							•		•			
3720							•		•		•			
3725							•		•		•			
3730							•		•		•			
3740							•		•		•			
3750/3751					•		•		•		•			
3760							•		•		•			
3770							•		•		•			
3775							•		•		•			
3780							•		•		•			
3790											•			
8600/8601	•											•		•

																OKS No.
	•	•				•						•				30
	•				•	•						•				300
	•	•	•	•	•	•										310
		•		•										•	•	340/341
	•	•		•	•											350
	•	•	•	•	•	•								•	•	352/3521
	•	•	•	•	•	•								•	•	353
	•	•	•	•	•	•								•	•	354/3541
																360
	•	•		•					•				•	•	•	370/371
	•	•	•	•	•	•										387
																390/391
	•	•	•	•										•	•	600/601
		•		•	•									•	•	631
			•	•	•								•	•	•	640/641
	•	•	•	•	•	•								•	•	670/671
		•		•	•								•	•	•	700/701
				•	•				•						•	1000
	•	•			•									•		3520
	•	•			•											3570/3571
																3601
	•	•		•	•											3710
•	•	•											•			3720
•	•	•											•			3725
•	•	•											•			3730
•	•	•											•			3740
	•	•	•	•	•									•	•	3750/3751
•	•		•	•	•											3760
•	•															3770
•	•															3775
•	•															3780
		•		•	•	•										3790
		•		•											•	8600/8601



















																<b>OKS No.</b>
•	•		•	•	•	•										<b>400</b>
•	•		•	•		•										<b>402</b>
•	•	•	•	•	•	•				•				•		<b>403</b>
•	•		•	•	•	•										<b>404</b>
•	•		•	•	•	•										<b>410</b>
•	•		•	•	•	•										<b>416</b>
•	•		•			•										<b>418</b>
•	•		•		•	•					•					<b>420</b>
•	•		•	•	•	•				•						<b>422</b>
•	•		•		•	•					•					<b>424</b>
•	•		•	•	•	•				•						<b>425</b>
•	•				•					•	•					<b>427</b>
•	•		•								•					<b>428</b>
•	•		•													<b>432</b>
•	•		•	•						•						<b>433</b>
		•	•	•	•				•					•	•	<b>450/451</b>
•	•															<b>464</b>
	•				•				•							<b>468</b>
	•				•				•							<b>469</b>
•	•		•	•	•	•										<b>470/471</b>
•	•		•	•		•										<b>472</b>
•	•	•	•								•					<b>473</b>
•	•		•	•		•										<b>475</b>
•	•		•	•	•	•										<b>476</b>
	•		•			•			•							<b>477</b>
•	•		•			•										<b>479</b>
•	•		•			•										<b>480/481</b>
					•					•						<b>490</b>
										•				•		<b>491</b>
		•			•					•	•			•		<b>495</b>

*Greases*

## SELECTION TABLE GREASES AND DRY LUBRICANTS

OKS No.															
<b><i>Greases</i></b>															
1110/1111	●						●		●		●				
1112							●		●	●					
1133		●					●			●					
1140	●						●								
1144	●						●			●					
1149	●								●						
1155	●	●					●			●					
4100				●											
4200	●						●								
4210	●			●				●	●	●					
4220	●			●				●		●	●				
4240	●			●				●	●						
VP980	●	●				●				●			●		
<b><i>Dry Lubricants</i></b>															
100	●	●		●											
110/111	●	●		●											
510/511	●	●		●					●						
521	●	●		●					●						
530	●			●											
536	●					●					●				
570/571	●	●						●							
575	●	●						●							
589	●	●		●					●						
1300/1301						●	●			●					
1710												●			
1750												●			
1765												●			



OKS No.















*Greases*

									•								<b>1110/1111</b>
									•								<b>1112</b>
•	•		•	•											•		<b>1133</b>
•	•																<b>1140</b>
•	•		•	•													<b>1144</b>
•	•		•			•											<b>1149</b>
			•	•	•	•			•		•						<b>1155</b>
•	•		•		•	•											<b>4100</b>
•	•		•														<b>4200</b>
•	•		•	•													<b>4210</b>
•	•		•	•													<b>4220</b>
•	•		•	•													<b>4240</b>
	•			•	•												<b>VP980</b>

*Dry Lubricants*

				•					•								<b>100</b>
			•	•	•	•					•						<b>110/111</b>
	•		•	•	•	•											<b>510/511</b>
	•		•	•	•	•											<b>521</b>
	•	•	•	•	•	•					•	•					<b>530</b>
		•		•	•												<b>536</b>
			•	•	•	•											<b>570/571</b>
	•		•	•	•	•	•										<b>575</b>
	•		•	•	•	•					•					•	<b>589</b>
				•	•	•	•		•				•			•	<b>1300/1301</b>
							•		•								<b>1710</b>
							•		•								<b>1750</b>
							•		•								<b>1765</b>

## SELECTION TABLE CORROSION PROTECTION, MAINTENANCE PRODUCTS AND CLEANERS

OKS No.														
<b>Corrosion Protection</b>														
2100/2101					●	●	●				●			
2200					●							●		
2300/2301					●	●	●							
2511	●				●									
2521	●				●									
2531	●	●			●									
2541					●	●								
<b>Maintenance Products</b>														
611														
621		●												
1360/1361	●	●								●	●			
1510/1511										●				●
1600/1601												●		●
2711		●											●	
2731													●	
2800/2801														●
2811		●												
2901														
<b>Cleaners</b>														
2610/2611														●
2621													●	
2631														
2650											●			●
2660/2661														●
2670/2671											●			●
2681												●		



OKS No.







<i>Corrosion Protection</i>																
															●	2100/2101
															●	2200
															●	2300/2301
															●	2511
															●	2521
															●	2531
															●	2541

<i>Maintenance Products</i>																
															●	611
															●	621
															●	1360/1361
															●	1510/1511
															●	1600/1601
																2711
															●	2731
															●	2800/2801
															●	2811
															●	2901

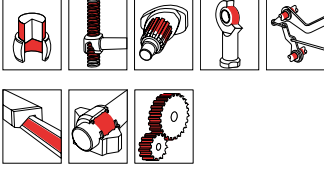
<i>Cleaners</i>																
															●	2610/2611
															●	2621
																2631
															●	2650
															●	2660/2661
															●	2670/2671
															●	2681

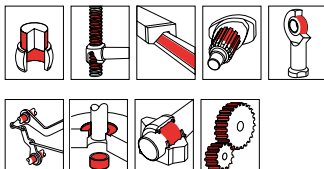
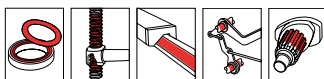
## PASTES FOR EASY ASSEMBLY AND DISMANTLING

### Pastes

Product	Designation	Fields of Application	Purpose
<b>OKS 200</b>	MoS <sub>2</sub> Assembly Paste		<ul style="list-style-type: none"> <li>• Assembly lubrication for press-on processes</li> <li>• Run-in lubrication of highly loaded sliding surfaces</li> <li>• Lubricant for difficult moulding processes</li> <li>• Prevents wearing, stick-slip, seizing, run-in damage or pitting</li> <li>• For universal use</li> </ul>
<b>Mo<sub>x</sub>-Active</b>			
<b>OKS 217</b>	High-Temperature Paste, high purity		<ul style="list-style-type: none"> <li>• Assembly lubrication of screw threaded connection made of high-strength steel, at high temperatures in aggressive environment</li> <li>• Optimum ratio of screw tightening torque to achievable pre-tension</li> <li>• No burning together and rusting on</li> <li>• No reaction with metals</li> <li>• For use in the chemical industry</li> </ul>
<b>OKS 220</b> <b>OKS 221*</b>	MoS <sub>2</sub> Rapid Paste		<ul style="list-style-type: none"> <li>• Assembly lubrication for press-on processes</li> <li>• Run-in lubrication of highly loaded sliding surfaces</li> <li>• Lubricant for difficult moulding processes</li> <li>• Effective immediately through high MoS<sub>2</sub> share</li> <li>• Rubbing in the paste not required</li> <li>• High-quality assembly paste</li> </ul>
<b>Mo<sub>x</sub>-Active</b>			
<b>OKS 230</b>	MoS <sub>2</sub> High-Temperature Paste		<ul style="list-style-type: none"> <li>• For high-temperature applications up to 450°C (dry lubrication from approx. 200°C)</li> <li>• Prevents wearing, stick-slip, seizing, run-in damage, pitting</li> <li>• Carrier oil evaporates residue-free from 200°C upwards</li> <li>• Bearings of pouring ladles, converters, kiln cars, or similar</li> <li>• Relubrication in operation with OKS 310</li> </ul>
<b>OKS 235</b> <b>OKS 2351*</b>	Aluminium Paste, Anti-Seize Paste		<ul style="list-style-type: none"> <li>• For assembling screw and bolt threaded connections that are subjected to high temperatures and corrosive influences</li> <li>• Optimum ratio of screw tightening torque to achievable pre-tension</li> <li>• Prevents burning together or rusting on</li> <li>• Prevents seizing</li> <li>• Use as lubricating and separating paste</li> </ul>
<b>OKS 240</b> <b>OKS 241*</b>	Antiseize Paste (Copper Paste)		<ul style="list-style-type: none"> <li>• For assembling screw threaded connections subjected to high temperatures and corrosive influences</li> <li>• Prevents burning together or rusting on</li> <li>• Optimum ratio of screw tightening torque to achievable pre-tension</li> <li>• Classic anti-seize paste</li> </ul>
<b>OKS 245</b>	Copper Paste with High Corrosion Protection		<ul style="list-style-type: none"> <li>• For screws, bolts and sliding surfaces subjected to high temperatures, water or sea water</li> <li>• Prevents burning together and rusting on</li> <li>• Prevents seizing during assembly</li> <li>• Highly adhesive</li> <li>• Excellent corrosion protection</li> <li>• Suitable for brake systems</li> </ul>

**Pastes**

Properties / Approvals	Main Components	Technical Data	Packaging
	black $\text{MoS}_2$ graphite other solid lubricants $\text{Mo}_x$ -Active synthetic oil lithium soap	Operating temperature: $-35^\circ\text{C} \rightarrow +450^\circ\text{C}$ Press-fit: $\mu = 0.09$ , no chatter Four-ball test rig (welding load): 2,400 N Thread friction (M10/8.8): not applicable	40 ml tube 250 g tin 1 kg tin 5 kg hobbock 25 kg hobbock
	black-grey semi-synthetic oil	Operating temperature: $-40^\circ\text{C} \rightarrow +1,400^\circ\text{C}$ Press-fit: $\mu = 0.11$ , Chatter from 4,000 N Four-ball test rig (welding load): 4,400 N Thread friction (M10/8.8): $\mu = 0.10$	250 g brush tin 1 kg tin 5 kg hobbock
	black $\text{MoS}_2$ other solid lubricants $\text{Mo}_x$ -Active synthetic oil	Operating temperature: $-35^\circ\text{C} \rightarrow +450^\circ\text{C}$ Press-fit: $\mu = 0.05$ , no chatter Four-ball test rig (welding load): 4,200 N Thread friction (M10/8.8): not applicable	250 g tin 1 kg tin 5 kg hobbock 400 ml aerosol*
	black $\text{MoS}_2$ other solid lubricants polyglycol lithium soap	Operating temperature: $-35^\circ\text{C} \rightarrow +180^\circ\text{C}/+450^\circ\text{C}$ (lubrication/separation) Press-fit: $\mu = 0.11$ Four-ball test rig (welding load): 3,200 N Thread friction (M10/8.8): $\mu = 0.10$	250 g tin 1 kg tin 5 kg hobbock 25 kg hobbock
	metallic silver aluminium powder other solid lubricants synthetic oil inorganic thickener	Operating temperature: $-40^\circ\text{C} \rightarrow +1,100^\circ\text{C}$ Press-fit: n.a. Four-ball test rig (welding load): n.a. Thread friction (M10/8.8): $\mu = 0.12$	250 g brush tin 1 kg tin 5 kg hobbock 400 ml aerosol*
	copper brown copper powder $\text{MoS}_2$ other solid lubricants synthetic oil inorganic thickener	Operating temperature: $-30^\circ\text{C} \rightarrow +200^\circ\text{C}/+1,100^\circ\text{C}$ Press-fit: $\mu = 0.12$ , no chatter Four-ball test rig (welding load): 2,800 N Thread friction (M10/8.8): $\mu = 0.09$	8 ml tube 75 ml tube 250 g brush tin 1 kg tin 5 kg hobbock 25 kg hobbock 400 ml aerosol*
	copper-coloured copper powder corrosion protection additive semi-synthetic oil lithium soap	Operating temperature: $-30^\circ\text{C} \rightarrow +150^\circ\text{C}/+1,100^\circ\text{C}$ Press-fit: $\mu = 0.12$ , no chatter Four-ball test rig (welding load): 2,600 N Thread friction (M10/8.8): $\mu = 0.15$	250 ml brush tin 500 g tin 1 kg tin 5 kg hobbock 25 kg hobbock

## PASTES FOR EASY ASSEMBLY AND DISMANTLING

### Pastes

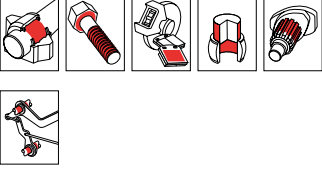
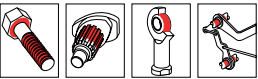
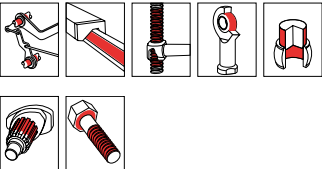
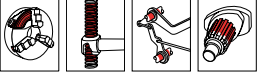
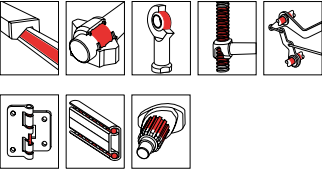
Product	Designation	Fields of Application	Purpose
<b>OKS 250</b> <b>OKS 2501*</b>	White Allround Paste, metal-free		<ul style="list-style-type: none"> <li>• For screws, bolts and sliding surfaces subjected to high pressures and temperatures</li> <li>• Metal-free</li> <li>• Optimum ratio of tightening torque to achievable pre-tension</li> <li>• Excellent corrosion protection</li> <li>• Also suitable for stainless-steel connections</li> <li>• Use as universal high-temperature paste</li> </ul>
<b>Mo<sub>x</sub>-Active</b>			
<b>OKS 252</b>	White High-Temperature Paste for Food Processing Technology		<ul style="list-style-type: none"> <li>• Lubrication of screws, bolts and sliding surfaces that are subjected to high pressures, high temperatures at low speeds or oscillating movements</li> <li>• Prevents burning together and rusting on</li> <li>• Metal-free</li> <li>• Highly adhesive</li> <li>• Universal high-temperature assembly paste</li> </ul>
<b>OKS 260</b>	White Assembly Paste		<ul style="list-style-type: none"> <li>• For screws, bolts and sliding surfaces subjected to high pressures at low speeds</li> <li>• Optimum ratio of tightening torque to achievable pre-tension</li> <li>• Prevents frictional corrosion</li> <li>• Metal-free</li> <li>• Waterproof</li> </ul>
<b>OKS 265</b>	Chuck Jaw Paste		<ul style="list-style-type: none"> <li>• For sliding surfaces subjected to high pressures, vibrations and impact loads</li> <li>• Optimum coefficient of sliding friction for high elasticity</li> <li>• Resistant to water and cooling lubricants</li> <li>• Prevents frictional corrosion</li> <li>• Especially for chucks on machine tools</li> </ul>
<b>OKS 270</b>	White Grease Paste		<ul style="list-style-type: none"> <li>• Long-term lubrication of sliding surfaces subjected to high pressures</li> <li>• Non-soiling alternative to black lubricants</li> <li>• Use as multipurpose grease paste, e.g. on textile, packaging or office machines and household appliances</li> </ul>



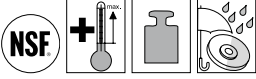
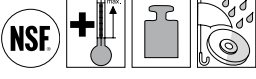
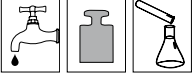
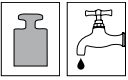

**Pastes**

Properties / Approvals	Main Components	Technical Data	Packaging
 OKS 250: NSF H2 Reg. No. 131379	beige white solid lubricants Mo <sub>x</sub> -Active synthetic oil polycarbamide	Operating temperature: -40 °C → +200 °C/+1,400 °C (lubrication/separation) Press-fit: $\mu = 0.10$ , no chatter Four-ball test rig (welding load): 3,600 N Thread friction (M10/8.8): $\mu = 0.12$	8 ml tube 80 ml tube 250 g brush tin 1 kg tin 5 kg hobbock 25 kg hobbock 400 ml aerosol*
 NSF H1 Reg. No. 135748	light grey white solid lubricants polyglycol silicate	Operating temperature: -30 °C → +160 °C/+1,200 °C (lubrication/separation) Press-fit: $\mu = 0.12$ , no chatter Thread friction (M10/8.8): $\mu = 0.15$	200 g dispenser 250 g brush tin 1 kg tin
	light-coloured white solid lubricants white oil lithium soap	Operating temperature: -25 °C → +150 °C Press-fit: $\mu = 0.09$ , no chatter Four-ball test rig (welding load): 2,600 N Thread friction (M10/8.8): $\mu = 0.08$	250 g tin 1 kg tin 5 kg hobbock 25 kg hobbock
	light-coloured white solid lubricants polyalphaolefin (PAO) lithium soap	Operating temperature: -45 °C → +110 °C Press-fit: not applicable Four-ball test rig (welding load): 4,200 N Thread friction (M10/8.8): $\mu = 0.10$	400 ml cartridge 1 kg tin 5 kg hobbock 25 kg hobbock
	light-coloured PTFE white solid lubricants white oil lithium soap	Operating temperature: -25 °C → +125 °C Press-fit: $\mu = 0.14$ , no chatter Four-ball test rig (welding load): 5,000 N Thread friction (M10/8.8): $\mu = 0.09$	250 g tin 1 kg tin 5 kg hobbock 25 kg hobbock

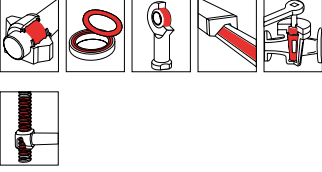
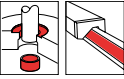

## PASTES FOR EASY ASSEMBLY AND DISMANTLING

### Pastes

Product	Designation	Fields of Application	Purpose
<b>OKS 277</b> <b>OKS 2771*</b>	High-Pressure Lubrication Paste with PTFE		<ul style="list-style-type: none"> <li>• Lubrication of heavily loaded press and guide plates</li> <li>• Lubrication and sealing of fittings made of metal, plastic and ceramic</li> <li>• Long regreasing intervals</li> <li>• Good plastic and elastomer compatibility</li> <li>• Highly adhesive</li> <li>• Use as lubrication paste, e.g. for telescope booms of mobile cranes</li> </ul>
<b>OKS 280</b>	White High-Temperature Paste		<ul style="list-style-type: none"> <li>• Lubricating paste for temperature-stressed sliding surfaces</li> <li>• Good separating effect through optimal solid lubricant combinations</li> <li>• Prevents carburising of tools and workpieces</li> <li>• Extends tool lives</li> <li>• Use as separating paste at thermoforming processes</li> </ul>
<b>OKS 1103</b>	Heat Sink Paste		<ul style="list-style-type: none"> <li>• Protection of sensitive electronic components against overheating</li> <li>• High thermal conductivity, 20 times better than at air</li> <li>• Electrically insulating</li> <li>• No drying out, hardening or bleeding</li> <li>• For thermal coupling of electronic components such as sensors, probes, diodes, transistors, etc. to cooling plates</li> </ul>
<b>OKS 1105</b>	Insulating Paste		<ul style="list-style-type: none"> <li>• Sealing lubrication for electrical or electronic equipment</li> <li>• Highly adhesive on glass, porcelain and plastics</li> <li>• Excellent resistance to chemical and weather-based influences</li> <li>• Small change in the dielectric properties across a wide temperature range</li> <li>• For protection of insulators and switchgear in a humid atmosphere</li> </ul>

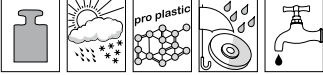

**Pastes**

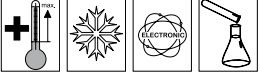
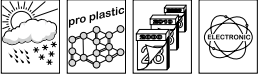
Properties / Approvals	Main Components	Technical Data	Packaging
	white PTFE ester	Operating temperature: $-20^{\circ}\text{C} \rightarrow +150^{\circ}\text{C}$ Four-ball test rig (welding load): 2,200 N	1 kg tin 25 kg hobbock 400 ml aerosol*
	white white solid lubricants mineral oil lithium soap	Operating temperature: $-15^{\circ}\text{C} \rightarrow +1,150^{\circ}\text{C}$ Press-fit: n.a. Four-ball test rig (welding load): 2,400 N Thread friction (M10/8.8): $\mu = 0.09$	1 kg tin 5 kg hobbock 25 kg hobbock
	white metal oxides silicone oil inorganic thickener	Operating temperature: $-40^{\circ}\text{C} \rightarrow +180^{\circ}\text{C}$ Thermal conductivity: approx. 0.7 W/mK Dielectric strength (20 °C): approx. 19 kV/mm Thermal capacity (21 °C): approx. 1.03 J/cm <sup>3</sup> K	40 ml tube 500 g tin 5 kg hobbock
	light-coloured silicone oil inorganic thickener	Operating temperature: $-40^{\circ}\text{C} \rightarrow +200^{\circ}\text{C}$ Specific resistivity (25 °C): approx. $10^{14} \Omega\text{cm}$ Dielectric constant ( $10^2 - 10^5 \text{ Hz}$ ): 2.75 Dielectric strength (0.05 inch): approx. 35 kV/mm	500 g tin 5 kg hobbock



## OILS WITH HIGH-PERFORMANCE ADDITIVES FOR RELIABLE LUBRICATION

### Oils

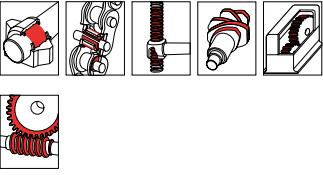
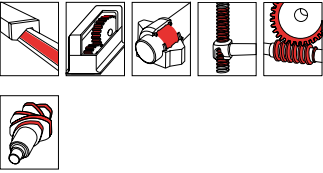
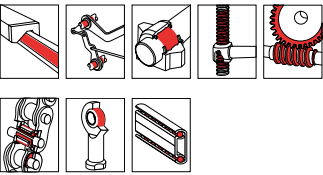
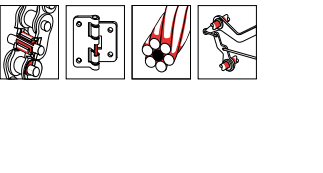
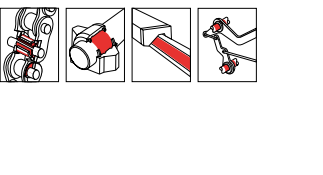
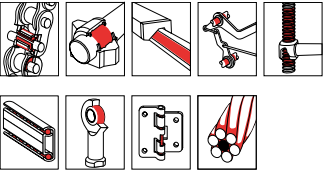



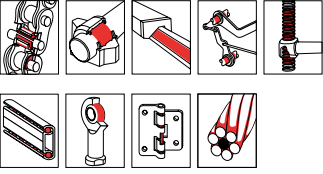
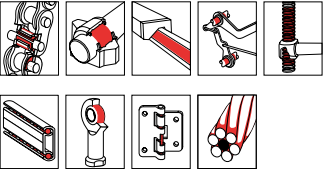
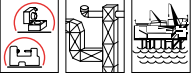
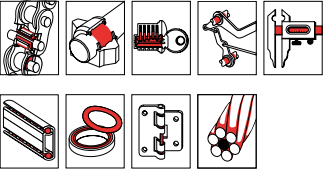
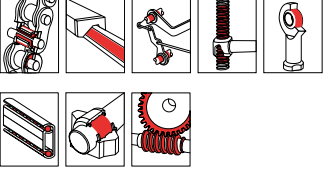
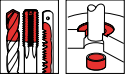
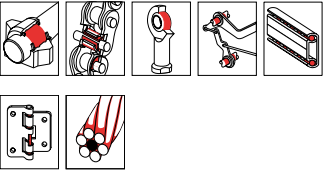

Product	Designation	Fields of Application	Purpose
<b>OKS 30</b> <i>Mo<sub>x</sub>-Active</i>	<b>Mo<sub>x</sub>-Active Additive</b>		<ul style="list-style-type: none"> <li>• EP additive for universal use as additive to industrial oils</li> <li>• Improves the run-in lubrication of new and overhauled machines</li> <li>• Smoothing of the surfaces results in lower wear and thermal loading of the lubricant</li> <li>• Makes longer lubricating intervals possible</li> </ul>
<b>OKS 300</b> <i>Mo<sub>x</sub>-Active</i>	<b>MoS<sub>2</sub> Mineral Oil-Concentrate</b>  ISO VG 100		<ul style="list-style-type: none"> <li>• Additive on MoS<sub>2</sub> and Mo<sub>x</sub> basis</li> <li>• Reduces friction, temperature and wear</li> <li>• Smoothens the surfaces</li> <li>• Creates emergency-running properties</li> <li>• Passes common filters, does not react to magnetic filters</li> <li>• Additive to gear, engine and machine oils</li> </ul>
<b>OKS 310</b> <i>Mo<sub>x</sub>-Active</i>	<b>MoS<sub>2</sub>-High-Temperature Lubricating Oil</b>  ISO VG 100		<ul style="list-style-type: none"> <li>• Lubrication of machine elements up to +450 °C</li> <li>• Residue-free evaporation of the base oil above +200 °C</li> <li>• Dry lubrication from +200 °C to +450 °C</li> <li>• Lubrication in steelworks, foundries, rolling mills, ceramics industry</li> </ul>
<b>OKS 340</b> <b>OKS 341*</b> <i>Mo<sub>x</sub>-Active</i>	<b>Chain Protector, strongly adhesive</b>  ISO VG 460 DIN 51 502: CLP X 460		<ul style="list-style-type: none"> <li>• Synthetic lubricant for machine elements subjected to high pressure or corrosive influences</li> <li>• Extremely high creep capacity</li> <li>• Highly adhesive and resistant to throwing off</li> <li>• Excellent wear protection</li> <li>• O-ring neutral</li> <li>• For fast-running chains</li> </ul>
<b>OKS 350</b> <i>Mo<sub>x</sub>-Active</i>	<b>High-Temperature Chain Oil with MoS<sub>2</sub>, synthetic</b>  ISO VG 220		<ul style="list-style-type: none"> <li>• Synthetic oil for machine elements at high temperatures</li> <li>• Highly load-bearing capacity due to finest, homogeneous MoS<sub>2</sub> distribution in oil</li> <li>• Emergency running properties through MoS<sub>2</sub> at dry running</li> <li>• Outstanding adhesion and lubrication effect with no tendency to drip or dry out</li> <li>• Silicone-free</li> </ul>
<b>OKS 352</b> <b>OKS 3521*</b> <i>Mo<sub>x</sub>-Active</i>	<b>High-Temperature Oil, light-coloured, synthetic</b>  DIN 51 502: CLP E 320		<ul style="list-style-type: none"> <li>• Synthetic high-temperature oil</li> <li>• Good wear protective through EP additives</li> <li>• Excellent oxidation protection, therefore resistant to ageing</li> <li>• Low tendency to drip at high temperatures</li> <li>• Minimal evaporation losses</li> <li>• Residue-free evaporation</li> <li>• Good water and steam resistance</li> </ul>

Properties / Approvals	Main Components	Technical Data	Packaging
	greenish Mo <sub>x</sub> -Active ester	Operating temperature: n.a. Density (20 °C): 1.03 g/ml Viscosity (40 °C): 70 mm <sup>2</sup> /s	1 l tin 5 l canister
	black MoS <sub>2</sub> Mo <sub>x</sub> -Active mineral oil	Operating temperature: n.a. Density (20 °C): 0.92 g/ml Viscosity (40 °C): approx. 90 mm <sup>2</sup> /s Four-ball test rig (welding load): n.a.	1 l tin 5 l canister 25 l canister 200 l drum
	black MoS <sub>2</sub> polyglycol	Operating temperature: → +200 °C/+450 °C Density (20 °C): 1.01 g/ml Viscosity (40 °C): approx. 108 mm <sup>2</sup> /s Four-ball test rig (welding load): 2,800 N	1 l tin 5 l canister 25 l canister
	brown-transparent Mo <sub>x</sub> -Active adhesion improver polyisobutylene	Operating temperature: -30 °C → +180 °C Density (20 °C): 0.90 g/ml Viscosity (40 °C): 470 mm <sup>2</sup> /s Four-ball test rig (welding load): 2,600 N	1 l tin 5 l canister 25 l canister 200 l drum 400 ml aerosol*
	black MoS <sub>2</sub> Mo <sub>x</sub> -Active synthetic oil	Operating temperature: -30 °C → +250 °C Density (20 °C): 0.90 g/ml Viscosity (40 °C): 240 mm <sup>2</sup> /s	5 l canister 25 l canister 200 l drum
	yellowish ester	Operating temperature: -10 °C → +250 °C Density (20 °C): 0.90 g/ml Viscosity (40 °C): 270 mm <sup>2</sup> /s Four-ball test rig (welding load): 2,400 N	120 cm <sup>3</sup> CL-cartridge 1 l tin 5 l canister 25 l canister 200 l drum 400 ml aerosol*

## OILS WITH HIGH-PERFORMANCE ADDITIVES FOR RELIABLE LUBRICATION

### Oils

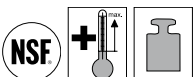
Product	Designation	Fields of Application	Purpose
<b>OKS 353</b>	High-Temperature Oil, light-coloured, synthetic  ISO VG 100 DIN 51 502: CLP E 100		<ul style="list-style-type: none"> <li>• Synthetic high-temperature oil</li> <li>• Good wear protective through EP additives</li> <li>• Excellent oxidation protection, therefore resistant to ageing</li> <li>• Low tendency to drip at high temperatures</li> <li>• Minimal evaporation losses</li> <li>• Residue-free evaporation</li> <li>• Good cleaning action</li> </ul>
<b>OKS 354</b> <b>OKS 3541*</b>	High-Temperature Adhesive Lubricant, synthetic  DIN 51 502: CLP E 4.000		<ul style="list-style-type: none"> <li>• Lubrication of machine elements at high temperatures or strong influence of water</li> <li>• Excellent oxidation protection, therefore resistant to ageing</li> <li>• Excellent resistance against water, steam and aggressive media</li> <li>• Extremely adhesive</li> </ul>
<b>Mo<sub>x</sub>-Active</b>	DIN 51 502: CLP E 4.000		
<b>OKS 360</b> <i>New Formulation!</i>	High-Performance Corrosion Protection Oil for Food Processing Technology		<ul style="list-style-type: none"> <li>• Excellent corrosion protection of bare machine parts, also for food processing technology</li> <li>• Storage and lubrication under corrosive conditions</li> <li>• Good creep properties</li> <li>• Contains non-ferrous metal deactivator</li> <li>• Shipping protection of metal surfaces, packed and unpacked machines under extreme climatic conditions, industrial atmosphere or at outdoor weathering under roof</li> </ul>
<b>OKS 370</b> <b>OKS 371*</b>	Multipurpose Oil for Food Processing Technology  ISO VG 15 DIN 51 502: CL 15		<ul style="list-style-type: none"> <li>• High-performance oil for precision machine elements</li> <li>• Tasteless and odourless</li> <li>• Extremely high creep capacity</li> <li>• Displaces water</li> <li>• Dissolves dirt and rust</li> <li>• Washed out of textiles</li> <li>• For use in textile and packaging industry</li> </ul>
<b>OKS 387</b>	High-Temperature Chain Lubricant for Food Processing Technology  ISO VG 220		<ul style="list-style-type: none"> <li>• Synthetic lubricant with graphite for strongly loaded lubrication points at extreme temperatures</li> <li>• Reduces wear</li> <li>• Excellent lubricating and emergency running properties</li> <li>• Base oil that evaporates odourlessly and residue-free above +200 °C</li> <li>• Dry lubrication up to +600 °C</li> </ul>
<b>OKS 390</b> <b>OKS 391*</b>	Cutting Oil for all Metals		<ul style="list-style-type: none"> <li>• For machining work on all metals</li> <li>• Permits high cutting speeds</li> <li>• Reduces application of force</li> <li>• Results in optimum cutting surfaces and extended tool life</li> <li>• For universal use in workshops and during assembly work</li> </ul>
<b>OKS 600</b> <b>OKS 601*</b>	Multi Oil  DIN 51 502: CL 3		<ul style="list-style-type: none"> <li>• Low-viscosity multipurpose oil</li> <li>• Excellent creep properties</li> <li>• Excellent corrosion protection</li> <li>• Dismantling rusted-in parts</li> <li>• Excellent lubricating properties</li> <li>• Displaces moisture</li> <li>• For cleaning and care of metal surfaces</li> <li>• Protects electrical contacts</li> </ul>

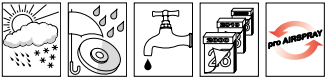

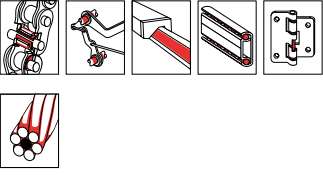
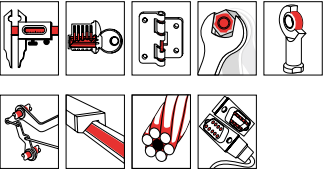
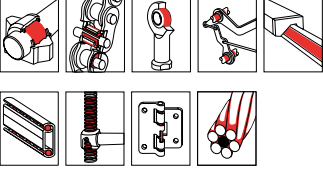
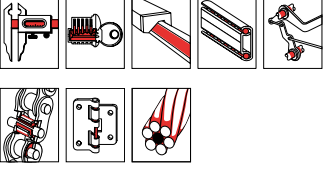
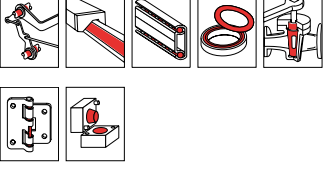
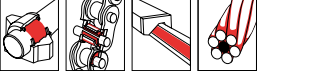

Properties / Approvals	Main Components	Technical Data	Packaging
	yellow ester	Operating temperature: -25 °C → +250 °C Density (20 °C): 0.91 g/ml Viscosity (40 °C): 100 mm <sup>2</sup> /s Four-ball test rig (welding load): 2,000 N	1 l tin 5 l canister 25 l canister 200 l drum
	yellowish Mo <sub>x</sub> -Active ester	Operating temperature: -10 °C → +250 °C Density (20 °C): 0.91 g/ml Viscosity (40 °C): 4,000 mm <sup>2</sup> /s Four-ball test rig (welding load): 2,200 N	1 l tin 5 l canister 25 l canister 200 l drum 400 ml aerosol*
  NSF H1 Reg. No. 153877	yellowish brown polyalphaolefin ( PAO)	Operating temperature: -40 °C → +80 °C Density (20 °C): 0.81 g/ml Viscosity (40 °C): > 21,5 mm <sup>2</sup> /s Salt spray test: > 100 h	5 l canister 25 l canister
  OKS 370: NSF H1 Reg. No. 124382 OKS 371: NSF H1 Reg. No. 124384	colourless white oil	Operating temperature: -10 °C → +180 °C Density (20 °C): 0.88 g/ml Viscosity (40 °C): 14 mm <sup>2</sup> /s	5 l canister 25 l canister 200 l drum 400 ml aerosol*
  NSF H1 Reg. No. 126583	black graphite polyglycol	Operating temperature: max. +600 °C Density (20 °C): 1.04 g/ml Viscosity (40 °C): 190 mm <sup>2</sup> /s Four-ball test rig (welding load): 2,800 N	5 l canister 25 l canister
	yellowish mineral oil	Operating temperature: not applicable Density (20 °C): 0.87 g/ml Viscosity (40 °C): 22 mm <sup>2</sup> /s	250 ml bottle 5 l canister 25 l canister 200 l drum 400 ml aerosol*
	brownish transparent mineral oil	Operating temperature: -30 °C → +60 °C / 150 °C (After evaporation of the solvent) Density (20 °C): 0.81 g/ml Base oil viscosity (40 °C): approx. 3 mm <sup>2</sup> /s Salt spray test: > 50 h	5 l canister 25 l canister 200 l drum 400 ml aerosol*

## OILS WITH HIGH-PERFORMANCE ADDITIVES FOR RELIABLE LUBRICATION

### Oils

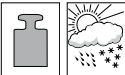

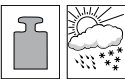
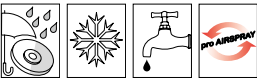
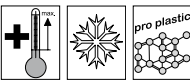
Product	Designation	Fields of Application	Purpose
<b>OKS 631</b> <i>New</i>	Multi Oil PLUS with PTFE		<ul style="list-style-type: none"> <li>• Multifunction oil with PTFE for a wide range of applications in maintenance and servicing</li> <li>• Protects reliably against friction and wear even at high loads and slow movements</li> <li>• Good protection against corrosion and lubricant film with good adhesive properties through optimal additive combination</li> <li>• The good penetration properties allow the lubrication of points that are difficult to access, e.g. joints, hinges and chain inner bearings</li> </ul>
<b>OKS 640</b> <b>OKS 641*</b> <i>New Formulation!</i>	Maintenance Oil		<ul style="list-style-type: none"> <li>• For dismantling, lubrication and care of machine elements and metal surfaces</li> <li>• Good cleaning action</li> <li>• Temporary protection against corrosion</li> <li>• Displaces moisture</li> <li>• For use in industry and workshop field</li> </ul>
<b>OKS 670</b> <b>OKS 671*</b> <i>New Formulation!</i>	High-Performance Lube Oil with white Solid Lubricants  analogue to DIN 51 502: CLF 15		<ul style="list-style-type: none"> <li>• Long-term lubrication of machine elements subjected to high pressures, dust or moisture</li> <li>• Excellent corrosion protection</li> <li>• Good creep properties</li> <li>• Lubrication wherever good penetration capacity is the only possibility for relubrication, e.g. at joints, hinges, levers and guides</li> </ul>
<b>OKS 700</b> <b>OKS 701*</b>	Synthetic Oil  DIN 51 502: CL X 15		<ul style="list-style-type: none"> <li>• For lubrication and care of high-precision machine elements</li> <li>• Resin and acid-free</li> <li>• Good creep behaviour</li> <li>• Excellent wetting behaviour</li> <li>• Compatible with plastics</li> <li>• For use on measuring instruments in precision mechanics or optics</li> </ul>
<b>OKS 1000</b>	Silicone Oil		<ul style="list-style-type: none"> <li>• Lubricant and parting agents for plastics and elastomers</li> <li>• Also as damping oil</li> <li>• Neutral with respect to plastics, elastomers or paints</li> <li>• Broad temperature application range</li> <li>• Excellent surface wetting</li> <li>• Resin and acid-free</li> <li>• Available in viscosities of 50 to 5000 cSt</li> </ul>
<b>OKS 3520</b> <i>New</i>	Extreme-Temperature Oil, light-coloured, synthetic  analogue to DIN 51 502: CLP E 150		<ul style="list-style-type: none"> <li>• Fully synthetic extreme temperature oil</li> <li>• Excellent wear protection at extremely high operating temperatures</li> <li>• Long period of use through high oxidation stability and minimal evaporation losses at temperatures up to 280 °C</li> <li>• For the lubrication of chains, hinges, slideways and clamping and drying frames in conveying systems, painting, stoving and drying installations</li> </ul>







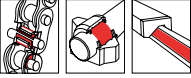

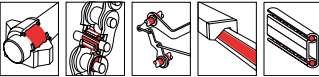
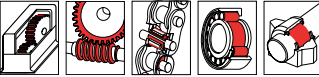
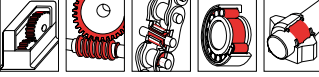
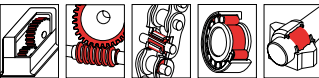
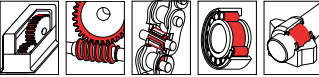
Properties / Approvals	Main Components	Technical Data	Packaging
	beige mineral oil PTFE	Operating temperature: -30 °C → +60 °C / 100 °C (After evaporation of the solvent) Density (20 °C): 0.83 g/ml Viscosity (40 °C): 5 mm <sup>2</sup> /s Coefficient of friction SRV: $\mu = 0.10$ Wear SRV: 0.001 mm <sup>3</sup> Salt spray test: 50 h	400 ml aerosol
	brown mineral oil solvent	Operating temperature: -30 °C → +60 °C / 150 °C (After evaporation of the solvent) Density (20 °C): 0.82 g/ml Viscosity (40 °C): 3 mm <sup>2</sup> /s Coefficient of friction SRV: $\mu = 0.11$ Wear SRV: 0.003 mm <sup>3</sup> Salt spray test: > 100 h	5 l canister 25 l canister 200 l drum 400 ml aerosol*
	beige white solid lubricants mineral oil	Operating temperature: -30 °C → +60 °C / 150 °C (After evaporation of the solvent) Density (20 °C): 0.82 g/ml Viscosity (40 °C): 18 mm <sup>2</sup> /s Coefficient of friction SRV: $\mu = 0.08$ Wear SRV: 0.002 mm <sup>3</sup> Salt spray test: > 150 h	5 l canister 25 l canister 200 l drum 400 ml aerosol*
	light brown polyisobutylene	Operating temperature: -50 °C → +100 °C Density (20 °C): 0.84 g/ml Viscosity (40 °C): 17.5 mm <sup>2</sup> /s Four-ball test rig (welding load): not applicable	5 l canister 25 l canister 100 ml aerosol* 400 ml aerosol*
 <p data-bbox="87 1507 320 1608">           OKS 1035/1:            NSF H1 Reg. No. 154506            OKS 1010/2:            NSF H1 Reg. No. 135921         </p>	colourless silicone oil	Operating temperature: -55 °C → +200 °C Density (20 °C): 0.96 – 0.97 g/ml Viscosity (25 °C): 50 – 5,000 mm <sup>2</sup> /s Four-ball test rig (welding load): n.a.	1 l tin 5 l canister 25 l canister 200 l drum
	yellowish ester	Operating temperature: -10 °C → +280 °C Density (20 °C): 0.97 g/ml Viscosity (40 °C): 150 mm <sup>2</sup> /s	5 l canister 25 l canister 200 l drum

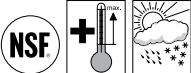
## OILS WITH HIGH-PERFORMANCE ADDITIVES FOR RELIABLE LUBRICATION



### Oils



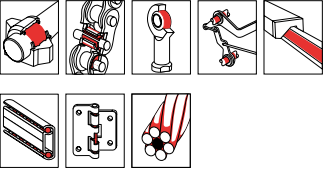
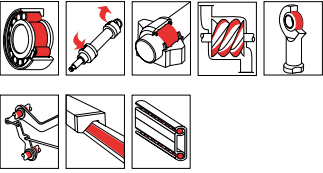

Product	Designation	Fields of Application	Purpose
<b>OKS 3570</b> <b>OKS 3571*</b>	High-Temperature Chain Oil for Food Processing Technology		<ul style="list-style-type: none"> <li>Lubrication of chains, hinges, joints, clamping and drying frames or slideways at high temperatures up to 250 °C</li> <li>Good adhesion on metal surfaces</li> <li>Excellent water resistance</li> <li>Excellent oxidation properties</li> <li>For use in conveying systems, painting, stoving and drying systems of the packaging and food processing industry</li> </ul>
<b>ChronoLube System</b>	ISO VG 320 DIN 51 502: CLP E 320		
<b>OKS 3601</b> <b>New</b>	High-Performance Corrosion Protection Oil for Food Processing Technology		<ul style="list-style-type: none"> <li>Excellent corrosion protection of bare machine parts, also for food processing technology</li> <li>Storage and lubrication under corrosive conditions</li> <li>Good creep properties</li> <li>Contains non-ferrous metal deactivator</li> <li>Shipping protection of metal surfaces, packed and unpacked machines under extreme climatic conditions, industrial atmosphere or at outdoor weathering under roof</li> </ul>
<b>OKS 3710</b>	Low-Temperature Oil for Food Processing Technology		<ul style="list-style-type: none"> <li>Fully synthetic oil for permanently low temperatures</li> <li>Excellent low-temperature behaviour</li> <li>Optimal additives against oxidation and ageing</li> <li>Long economic operating times</li> <li>For use in cold storage houses, shock freezers, etc.</li> </ul>
	ISO VG 10 DIN 51 502: CL HC 10		
<b>OKS 3720</b>	Gear Oil for Food Processing Technology		<ul style="list-style-type: none"> <li>Fully synthetic</li> <li>Also for the lubrication of rolling, friction bearings, chains and other lubricating points</li> <li>Long operating times due to high temperature and oxidation stability</li> <li>Good wear protection</li> <li>Resistant to steam, alkali and acid disinfectants and cleaning agents</li> </ul>
<b>ChronoLube System</b>	ISO VG 220 DIN 51 502: CLP HC 220		
<b>OKS 3725</b>	Gear Oil for Food Processing Technology		<ul style="list-style-type: none"> <li>Fully synthetic</li> <li>Also for the lubrication of rolling, friction bearings, chains and other lubricating points</li> <li>Long operating times due to high temperature and oxidation stability</li> <li>Good wear protection</li> <li>Resistant to steam, alkali and acid disinfectants and cleaning agents</li> </ul>
	ISO VG 320 DIN 51 502: CLP HC 320		
<b>OKS 3730</b>	Gear Oil for Food Processing Technology		<ul style="list-style-type: none"> <li>Fully synthetic</li> <li>Also for the lubrication of rolling, friction bearings, chains and other lubricating points</li> <li>Long operating times due to high temperature and oxidation stability</li> <li>Good wear protection</li> <li>Resistant to steam, alkali and acid disinfectants and cleaning agents</li> </ul>
	ISO VG 460 DIN 51 502: CLP HC 460		
<b>OKS 3740</b>	Gear Oil for Food Processing Technology		<ul style="list-style-type: none"> <li>Fully synthetic</li> <li>Also for the lubrication of rolling, friction bearings, chains and other lubricating points</li> <li>Long operating times due to high temperature and oxidation stability</li> <li>Good wear protection</li> <li>Resistant to steam, alkali and acid disinfectants and cleaning agents</li> </ul>
	ISO VG 680 DIN 51 502: CLP HC 680		

Properties / Approvals	Main Components	Technical Data	Packaging
 <p>OKS 3570: NSF H1 Reg. No. 145347 OKS 3571: NSF H1 Reg. No. 147769</p>	yellowish-red synthetic oil	Operating temperature: -10 °C → +250 °C Density (20 °C): 0.87 g/ml Viscosity (40 °C): 300 mm <sup>2</sup> /s	120 cm <sup>3</sup> CL-cartridge 5 l canister 25 l canister 200 l drum 400 ml aerosol*
 <p>NSF H1 Reg. No. 154933</p>	yellowish brown polyalphaolefin (PAO)	Operating temperature: -40 °C → +80 °C Density (20 °C): 0.81 g/ml Viscosity (40 °C): > 21.5 mm <sup>2</sup> /s Salt spray test: > 100 h	400 ml Spray
 <p>NSF H1 Reg. No. 142477</p>	colourless polyalphaolefin (PAO)	Operating temperature: -60 °C → +135 °C Density (20 °C): 0.80 g/ml Viscosity (40 °C): 7.25 mm <sup>2</sup> /s	5 l canister 25 l canister 200 l drum
 <p>NSF H1 Reg. No. 135752</p>	colourless synthetic oil mixture	Operating temperature: -30 °C → +120 °C Density (20 °C): 0.86 g/ml Viscosity (40 °C): 220 mm <sup>2</sup> /s FZG damage level: power level >12	120 cm <sup>3</sup> CL-cartridge 5 l canister 25 l canister 200 l drum
 <p>NSF H1 Reg. No. 143596</p>	colourless synthetic oil mixture	Operating temperature: -30 °C → +120 °C Density (20 °C): 0.85 g/ml Viscosity (40 °C): 320 mm <sup>2</sup> /s FZG damage level: power level >12	5 l canister 25 l canister
 <p>NSF H1 Reg. No. 135753</p>	colourless-hellyellow synthetic oil mixture	Operating temperature: -30 °C → +120 °C Density (20 °C): 0.86 g/ml Viscosity (40 °C): 460 mm <sup>2</sup> /s FZG damage level: power level >12	5 l canister 25 l canister 200 l drum
 <p>NSF H1 Reg. No. 135754</p>	colourless synthetic oil mixture	Operating temperature: -25 °C → +120 °C Density (20 °C): 0.86 g/ml Viscosity (40 °C): 680 mm <sup>2</sup> /s FZG damage level: power level >12	5 l canister 25 l canister

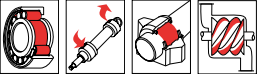
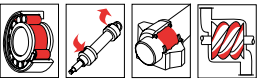
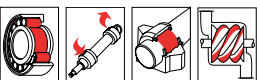
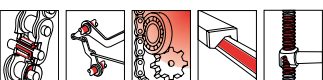
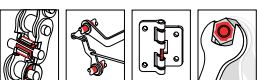
## OILS WITH HIGH-PERFORMANCE ADDITIVES FOR RELIABLE LUBRICATION



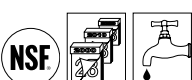
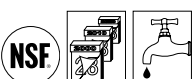



### Oils

Product	Designation	Fields of Application	Purpose
<b>OKS 3750</b> <b>OKS 3751*</b>	<b>Adhesive Lubricant with PTFE</b>  ISO VG 100 DIN 51 502: CLF HC 100		<ul style="list-style-type: none"> <li>• Lubricating oil with PTFE</li> <li>• Long operating times due to high temperature and oxidation stability</li> <li>• Excellent wear protection, adheres well</li> <li>• High pressure absorption capacity</li> <li>• Resistant to steam, alkali and acid disinfectants and cleaning agents</li> <li>• Tasteless and odourless</li> </ul>
<b>OKS 3760</b>	<b>Multipurpose Oil for Food Processing Technology</b>  ISO VG 100 DIN 51 502: HLP HC 100 DIN 51 502: VDL HC 100		<ul style="list-style-type: none"> <li>• Fully synthetic multipurpose oil</li> <li>• Also suitable as compressor- or hydraulic oil</li> <li>• Long operating times due to high temperature and oxidation stability</li> <li>• Good wear protection</li> <li>• Resistant to steam, alkali and acid disinfectants and cleaning agents</li> <li>• Tasteless and odourless</li> </ul>
			
<b>OKS 3770</b>	<b>Hydraulic Oil for Food Processing Technology</b>  ISO VG 46 DIN 51 502: HLP HC 46 DIN 51 502: VDL HC 46		<ul style="list-style-type: none"> <li>• Fully synthetic oil for hydraulic systems, as well as other machine elements</li> <li>• For screws and multiple vane rotary vacuum pumps</li> <li>• Long operating times due to high temperature and oxidation stability</li> <li>• Good wear protection</li> <li>• Resistant to steam, alkali and acid disinfectants and cleaning agents</li> </ul>
<b>OKS 3775</b>	<b>Hydraulic Oil for Food Processing Technology</b>  ISO VG 32 DIN 51 502: HLP HC 32 DIN 51 502: VDL HC 32		<ul style="list-style-type: none"> <li>• Fully synthetic oil for hydraulic systems, as well as other machine elements</li> <li>• For screws and multiple vane rotary vacuum pumps</li> <li>• Long operating times due to high temperature and oxidation stability</li> <li>• Good wear protection</li> <li>• Resistant to steam, alkali and acid disinfectants and cleaning agents</li> </ul>
<b>OKS 3780</b>	<b>Hydraulic Oil for Food Processing Technology</b>  ISO VG 68 DIN 51 502: HLP HC 68 DIN 51 502: VDL HC 68		<ul style="list-style-type: none"> <li>• Fully synthetic oil for hydraulic systems, as well as other machine elements</li> <li>• For screws and multiple vane rotary vacuum pumps</li> <li>• Long operating times due to high temperature and oxidation stability</li> <li>• Good wear protection</li> <li>• Resistant to steam, alkali and acid disinfectants and cleaning agents</li> </ul>
<b>OKS 3790</b>	<b>Sugar-Dissolving Oil, fully synthetic</b>		<ul style="list-style-type: none"> <li>• For dissolving sugar deposits and cleaning machine parts</li> <li>• Lubrication of precision mechanisms</li> <li>• Forming lubricant for packaging</li> <li>• Good cleaning and lubrication effect</li> <li>• Good wear and corrosion protection</li> <li>• Tasteless and odourless emulsion</li> <li>• Specially for use in the sweets industry</li> </ul>
<b>OKS 8600</b> <b>OKS 8601*</b>	<b>BIOLogic Multi Oil</b>  ISO VG 32 DIN 51 502: CLX 32		<ul style="list-style-type: none"> <li>• Universal biodegradable multipurpose oil in the temperature range up to 160°C</li> <li>• Good creep and lubrication properties</li> <li>• VOC-free</li> <li>• Silicone-free</li> <li>• For use in forestry, agriculture and water management</li> </ul>

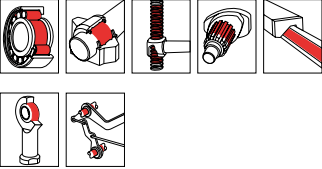
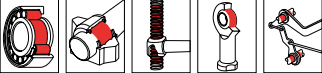
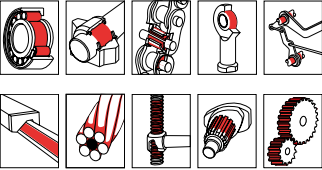

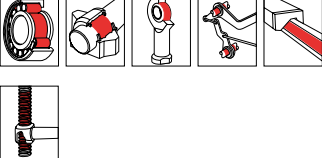

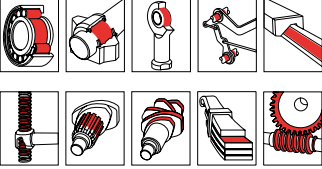
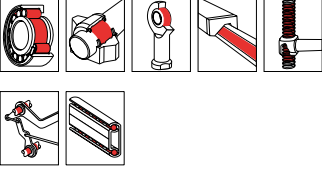

Properties / Approvals	Main Components	Technical Data	Packaging
 <p>OKS 3750: NSF H1 Reg. No. 124383 OKS 3751: NSF H1 Reg. No. 124801</p>	whitish PTFE polyalphaolefin (PAO)	Operating temperature: -35 °C → +135 °C Density (20 °C): 0.85 g/ml Viscosity (40 °C): 110 mm <sup>2</sup> /s Four-ball test rig (welding load): 2,600 N	5 l canister 400 ml aerosol*
 <p>NSF H1 Reg. No. 129964</p>	colourless polyalphaolefin (PAO)	Operating temperature: -35 °C → +135 °C Density (20 °C): 0.84 g/ml Viscosity (40 °C): 100 mm <sup>2</sup> /s	120 cm <sup>3</sup> CL-cartridge 1 l tin 5 l canister 25 l canister 200 l drum
 <p>NSF H1 Reg. No. 129962</p>	colourless polyalphaolefin (PAO)	Operating temperature: -40 °C → +135 °C Density (20 °C): 0.83 g/ml Viscosity (40 °C): 46 mm <sup>2</sup> /s	5 l canister 25 l canister 200 l drum
 <p>NSF H1 Reg. No. 143597</p>	colourless polyalphaolefin (PAO)	Operating temperature: -45 °C → +135 °C Density (20 °C): 0.83 g/ml Viscosity (40 °C): 32 mm <sup>2</sup> /s	5 l canister 25 l canister 200 l drum
 <p>NSF H1 Reg. No. 136036</p>	colourless polyalphaolefin (PAO)	Operating temperature: -40 °C → +135 °C Density (20 °C): 0.83 g/ml Viscosity (40 °C): 66 mm <sup>2</sup> /s	5 l canister 25 l canister 200 l drum
 <p>NSF H1 Reg. No. 128470</p>	colourless water polyglycol	Operating temperature: -5 °C → +80 °C Density (20 °C): 1.06 g/ml Viscosity (40 °C): 20 – 24 mm <sup>2</sup> /s	5 l canister 25 l canister
 <p>EU Ecolabel NL/27/008</p>	yellowish-light brown ester	Operating temperature: -5 °C → +160 °C Density (20 °C): 0.92 g/ml Viscosity (40 °C): 35 – 40 mm <sup>2</sup> /s	5 l canister 25 l canister 200 l drum 300 ml aerosol*

## GREASES FOR LONG-TERM LUBRICATION UNDER CRITICAL OPERATION CONDITIONS

### Greases

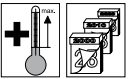

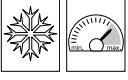

Product	Designation	Fields of Application	Purpose
<b>OKS 400</b>  	<b>MoS<sub>2</sub> Multipurpose High-Performance Grease</b>  DIN 51 502: KPF2K-30		<ul style="list-style-type: none"> <li>• For heavily loaded or impact-loaded rolling and friction bearings, spindles and joints</li> <li>• Forms an MoS<sub>2</sub> sliding film for emergency running properties</li> <li>• Reduces wear</li> <li>• Resistant to ageing and oxidation</li> <li>• High-pressure grease for universal use</li> </ul>
<b>OKS 402</b>	<b>Ball-Bearing High-Performance Grease</b>  DIN 51 502: K2K-30		<ul style="list-style-type: none"> <li>• For machine elements such as rolling and friction bearings, spindles and slideways under normal loads</li> <li>• Reduces wear</li> <li>• Good resistance to pressure and water</li> <li>• Resistant to ageing and oxidation</li> <li>• Multipurpose grease</li> <li>• Also available in NLGI grade 3</li> </ul>
<b>OKS 403</b>	<b>Marine Grease</b>  DIN 51 502: KP1-2E-20		<ul style="list-style-type: none"> <li>• Lubrication of machine elements subjected to water or sea water</li> <li>• Excellent corrosion protection</li> <li>• Adheres well</li> <li>• Has proven itself in wet operating environments and in coastal and marine areas</li> <li>• Suitable as water pump grease</li> </ul>
<b>OKS 404</b>  	<b>High-Performance and High-Temperature Grease</b>  DIN 51 502: KP2P-30		<ul style="list-style-type: none"> <li>• For lubricating high pressure loaded rolling and friction bearings in a wide temperature range</li> <li>• Reduces wear</li> <li>• Good pressure resistance</li> <li>• Good water resistance</li> <li>• Resistant to ageing and oxidation</li> <li>• Good corrosion protection</li> <li>• Modern grease with a wide range of applications</li> </ul>
<b>OKS 410</b>  	<b>MoS<sub>2</sub> High-Pressure Long-Life Grease</b>  DIN 51 502: KPF2K-20		<ul style="list-style-type: none"> <li>• Long-term lubrication of lubrication points subjected to pressure or impacts also under outdoor exposure</li> <li>• Good emergency running properties</li> <li>• Excellent wear protection</li> <li>• Good water resistance</li> <li>• Highly adhesive</li> <li>• For harsh conditions, e.g. in rolling mills, construction and agricultural machines, in mining and port operations</li> </ul>
<b>OKS 416</b>	<b>Low-Temperature and High-Speed Grease</b>  DIN 51 502: KPE2K-50		<ul style="list-style-type: none"> <li>• Supple consistency, also at low temperatures</li> <li>• Good wear protection</li> <li>• High dynamic load-bearing capacity</li> <li>• Good corrosion protection</li> <li>• Reliable lubrication of conveying equipment and spindle bearings in cold storage houses</li> <li>• Suitable as instrument grease</li> </ul>
<b>OKS 418</b>	<b>High-Temperature Grease</b>  DIN 51 502: KPF2N-20		<ul style="list-style-type: none"> <li>• Lubrication of friction and rolling bearings at higher temperatures</li> <li>• Long-term lubrication of lubrication points subjected to high pressure</li> <li>• Good wear protection</li> <li>• Good resistance to oxidation and ageing</li> <li>• Economic hot bearing grease without drop point</li> </ul>

## Greases

Properties / Approvals	Main Components	Technical Data	Packaging
	black $\text{MoS}_2$ mineral oil lithium soap	Operating temperature: $-30^\circ\text{C} \rightarrow +120^\circ\text{C}$ NLGI grade: 2 DN factor (dm x n): 300,000 mm/min Base oil viscosity (40°C): 100 mm <sup>2</sup> /s Four-ball test rig (welding load): 3,600 N	120 cm <sup>3</sup> CL-cartridge 80 ml tube 400 ml cartridge 1 kg tin 5 kg hobbock 25 kg hobbock 180 kg drum
	beige mineral oil lithium soap	Operating temperature: $-30^\circ\text{C} \rightarrow +120^\circ\text{C}$ NLGI grade: 2 DN factor (dm x n): 500,000 mm/min Base oil viscosity (40°C): 110 mm <sup>2</sup> /s Four-ball test rig (welding load): 2,000 N	400 ml cartridge 1 kg tin 5 kg hobbock 25 kg hobbock
	brown EP additive mineral oil calcium soap	Operating temperature: $-25^\circ\text{C} \rightarrow +80^\circ\text{C}$ NLGI grade: 1-2 DN factor (dm x n): 350,000 mm/min Base oil viscosity (40°C): 100 mm <sup>2</sup> /s Four-ball test rig (welding load): 3,000 N	400 ml cartridge 1 kg tin 5 kg hobbock 25 kg hobbock 180 kg drum
	light-coloured EP additive mineral oil polyalphaolefin (PAO) lithium-complex soap	Operating temperature: $-30^\circ\text{C} \rightarrow +150^\circ\text{C}$ NLGI grade: 2 DN factor (dm x n): 350,000 mm/min Base oil viscosity (40°C): 100 mm <sup>2</sup> /s Four-ball test rig (welding load): 2,800 N	120 cm <sup>3</sup> CL-cartridge 400 ml cartridge 1 kg tin 5 kg hobbock 25 kg hobbock 180 kg drum
	grey $\text{MoS}_2$ $\text{Mo}_x$ -Active mineral oil lithium soap	Operating temperature: $-20^\circ\text{C} \rightarrow +130^\circ\text{C}$ NLGI grade: 2 DN factor (dm x n): 500,000 mm/min Base oil viscosity (40°C): 185 mm <sup>2</sup> /s Four-ball test rig (welding load): 3,600 N	400 ml cartridge 1 kg tin 5 kg hobbock 25 kg hobbock 180 kg drum
 <p>Biodegradability: CEC-L-33-A93 21 days &gt; 70 %</p>	yellow EP additive semi-synthetic oil lithium soap	Operating temperature: $-50^\circ\text{C} \rightarrow +120^\circ\text{C}$ NLGI grade: 2 DN factor (dm x n): 1,000,000 mm/min Base oil viscosity (40°C): 15 mm <sup>2</sup> /s Four-ball test rig (welding load): 2,400 N	400 ml cartridge 1 kg tin 5 kg hobbock
	black $\text{MoS}_2$ mineral oil silicate	Operating temperature: $-25^\circ\text{C} \rightarrow +150^\circ\text{C}$ NLGI grade: 2 DN factor (dm x n): 400,000 mm/min Base oil viscosity (40°C): 220 mm <sup>2</sup> /s	1 kg tin 5 kg hobbock 25 kg hobbock



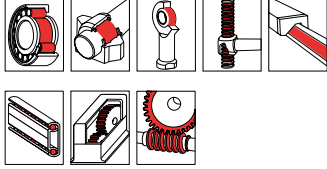

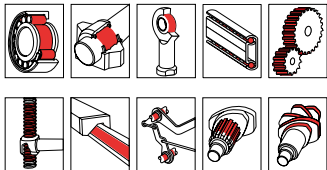
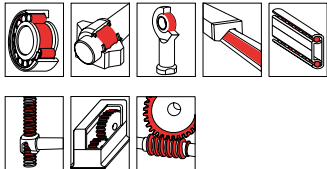
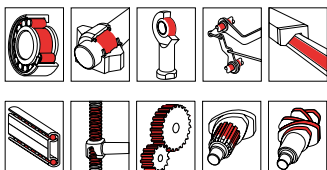
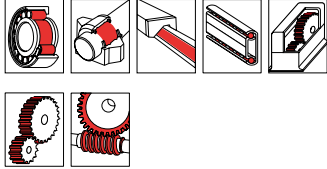
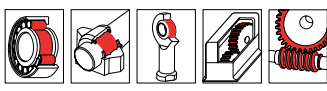
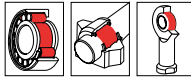
## GREASES FOR LONG-TERM LUBRICATION UNDER CRITICAL OPERATION CONDITIONS

### Greases

Product	Designation	Fields of Application	Purpose
<b>OKS 420</b>   	<b>High-Temperature Multipurpose Grease</b>  DIN 51 502: KP1-2P-10		<ul style="list-style-type: none"> <li>• For rolling and friction bearings, slow-running gears and chains at high temperatures, impact and pressure loads or water influences</li> <li>• Extremely impact and pressure-resistant</li> <li>• Good wear protection</li> <li>• Highly adhesive</li> <li>• For universal use at increased requirements</li> </ul>
	<b>OKS 422</b>  <b>Universal Grease for Long-Life Lubrication</b>  DIN 51 502: KPHC2N-40		<ul style="list-style-type: none"> <li>• For rolling and friction bearings and spindles at extreme temperatures or high speeds</li> <li>• Extremely impact and pressure-resistant</li> <li>• Excellent wear protection</li> <li>• Long regreasing intervals</li> <li>• Use outside normal performance areas</li> <li>• Spindle bearing lubrication at machine tools</li> </ul>
<b>OKS 424</b>	<b>Synthetic High-Temperature Grease</b>  DIN 51 502: KHC1-2S-30		<ul style="list-style-type: none"> <li>• For rolling and friction bearings at high temperatures and high loads</li> <li>• Good temperature resistance</li> <li>• Good plastic and elastomer compatibility</li> <li>• Good resistance against aggressive environmental influences</li> <li>• Suitable for lubrication of exhaust-gas fans</li> </ul>
<b>OKS 425</b>	<b>Synthetic Long-Life Grease</b>  DIN 51 502: KPHC2K-50		<ul style="list-style-type: none"> <li>• Long-term or for-life lubrication of machine elements that are subjected to high pressures and high temperatures</li> <li>• Excellent wear protection</li> <li>• For high speeds</li> <li>• Good temperature resistance</li> <li>• Spindle-bearing lubrication</li> </ul>
<b>OKS 427</b>	<b>Gear and Bearing Grease</b>  DIN 51 502: GP0/00P-10		<ul style="list-style-type: none"> <li>• For relatively slow-running gears, alternatively to oil lubrication</li> <li>• Lubrication of drive and transport chains, rolling and friction bearings</li> <li>• For high pressures, also at impact loads</li> <li>• Minimising of the losses for leaks in comparison to oil lubrication</li> <li>• Excellent wear protection</li> </ul>
<b>OKS 428</b>	<b>Fluid Grease for Gears, synthetic</b>  DIN 51 502: GPPG00K-40		<ul style="list-style-type: none"> <li>• For heavily loaded gearing exposed to weather outdoors and/or low temperatures, as well as angled or vertical shafts, also with gear designs which are not oil-tight</li> <li>• For friction bearings with low clearance or high speeds</li> <li>• For high pressures and impact loads</li> </ul>
<b>OKS 432</b>	<b>High Melting-Point Grease</b>  DIN 51 502: KP2R-20		<ul style="list-style-type: none"> <li>• For rolling and friction bearings and similar components, at high loads and temperatures</li> <li>• Excellent wear protection</li> <li>• Good resistance to oxidation and ageing</li> <li>• Good pressure resistance</li> <li>• Maintenance of lubricating effect even at high temperatures</li> </ul>

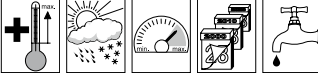

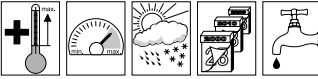
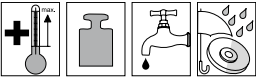

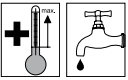

## Greases

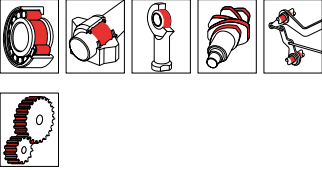

Properties / Approvals	Main Components	Technical Data	Packaging
	beige Mo <sub>x</sub> -Active mineral oil polycarbamide	Operating temperature: -10 °C → +160 °C NLGI grade: 1–2 DN factor (dm x n): 300,000 mm/min Base oil viscosity (40 °C): 490 mm <sup>2</sup> /s	120 cm <sup>3</sup> CL-cartridge 400 ml cartridge 1 kg tin 5 kg hobbock 25 kg hobbock 180 kg drum
	light-coloured EP additive polyalphaolefin (PAO) barium-complex soap	Operating temperature: -40 °C → +140 °C NLGI grade: 2 DN factor (dm x n): 800,000 mm/min Base oil viscosity (40 °C): 50 mm <sup>2</sup> /s Four-ball test rig (welding load): 3,400 N	120 cm <sup>3</sup> CL-cartridge 400 ml cartridge 1 kg tin 5 kg hobbock 25 kg hobbock 180 kg drum
	cream-coloured polyalphaolefin (PAO) polycarbamide	Operating temperature: -30 °C → +200 °C NLGI grade: 1–2 DN factor (dm x n): 350,000 mm/min Base oil viscosity (40 °C): 400 mm <sup>2</sup> /s Four-ball test rig (welding load): 1,800 N	400 ml cartridge 1 kg tin 5 kg hobbock 25 kg hobbock 180 kg drum
	beige EP additive polyalphaolefin (PAO) special calcium soap	Operating temperature: -50 °C → +130 °C NLGI grade: 2 DN factor (dm x n): 1,000,000 mm/min Base oil viscosity (40 °C): 30 mm <sup>2</sup> /s Four-ball test rig (welding load): 3,400 N	400 ml cartridge 1 kg tin
	brownish mineral oil synthetic oil polycarbamide	Operating temperature: -15 °C → +160 °C NLGI grade: 0 – 00 DN factor (dm x n): n.a. Base oil viscosity (40 °C): 490 mm <sup>2</sup> /s Four-ball test rig (welding load): n.a.	1 kg tin 5 kg hobbock 25 kg hobbock
	brown EP additive polyglycol lithium soap	Operating temperature: -30 °C → +120 °C NLGI grade: 00 DN factor (dm x n): 600,000 mm/min Base oil viscosity (40 °C): 120 mm <sup>2</sup> /s Four-ball test rig (welding load): 3,000 N	1 kg tin 5 kg hobbock 25 kg hobbock
	brown EP additive mineral oil aluminium-complex soap	Operating temperature: -25 °C → +190 °C NLGI grade: 2 DN factor (dm x n): 200,000 mm/min Base oil viscosity (40 °C): 230 mm <sup>2</sup> /s Four-ball test rig (welding load): 2,800 N	400 ml cartridge 1 kg tin 5 kg hobbock 25 kg hobbock 180 kg drum

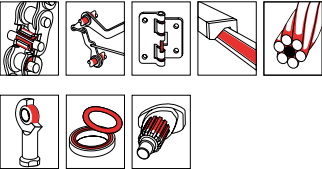
## GREASES FOR LONG-TERM LUBRICATION UNDER CRITICAL OPERATION CONDITIONS

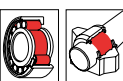
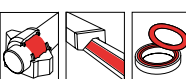
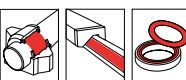
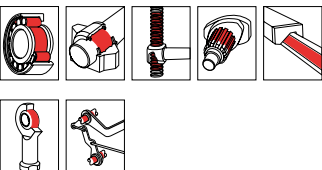
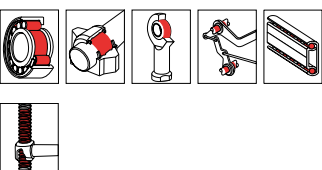
### Greases

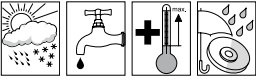
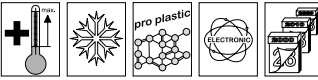
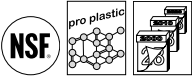
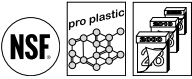

Product	Designation	Fields of Application	Purpose
<b>OKS 433</b>	<b>Long-Acting High-Pressure Grease</b>		<ul style="list-style-type: none"> <li>• For friction and rolling bearings at high pressures</li> <li>• EP additives</li> <li>• Good wear protection</li> <li>• Good resistance to oxidation and ageing</li> <li>• For heavily loaded rolling and taper roller bearings, e.g. on rolling stands, hot and cold shearing systems, sliding blocks and spindles</li> </ul>
<b>ChronoLube System</b>	DIN 51 502: KP2K-20		
<b>OKS 450</b> <b>OKS 451*</b>	<b>Chain Lubricant, transparent</b>		<ul style="list-style-type: none"> <li>• For fast-running chains and other machine elements subjected to high pressures or corrosive influences</li> <li>• Extremely high creep capacity</li> <li>• Highly adhesive, waterproof</li> <li>• Resistant to throwing off</li> <li>• Excellent wear protection</li> <li>• Suitable for lubricating flexible drives</li> </ul>
<b>ChronoLube System</b> <b>Mo<sub>x</sub>-Active</b>	ISO VG 320 DIN 51 502: CLP X 320		
<b>OKS 464</b>	<b>Electrically Conductive Rolling Bearing Grease</b>		<ul style="list-style-type: none"> <li>• Special grease for long-term lubrication of rolling and friction bearings for avoiding electrostatic charging</li> <li>• Good resistance to oxidation and ageing in rolling bearings</li> <li>• For bearings in motors, sheet drawing systems, sheet printing machines, etc.</li> </ul>
	DIN 51 502: KHC2N-40		
<b>OKS 468</b> <b>New</b>	<b>Plastic and Elastomer Grease</b>		<ul style="list-style-type: none"> <li>• Lubricating and sealing grease for plastic/plastic and plastic/metal combinations</li> <li>• Good elastomer and plastic compatibility</li> <li>• EPDM compatible</li> <li>• Silicone-free, highly adhesive</li> <li>• Tasteless and odourless</li> </ul>
<b>OKS 469</b>	<b>Plastic and Elastomer Grease</b>		<ul style="list-style-type: none"> <li>• Lubricating and sealing grease for plastic/plastic and plastic/metal combinations</li> <li>• Good elastomer and plastic compatibility</li> <li>• Silicone-free</li> <li>• Highly adhesive</li> <li>• Does not affect the quality properties of beer foam</li> <li>• Tasteless and odourless</li> </ul>
<b>OKS 470</b> <b>OKS 471*</b>	<b>White Universal High-Performance Grease</b>		<ul style="list-style-type: none"> <li>• For heavily loaded rolling and friction bearings, spindles and slideways when dark-coloured lubricants cannot be used</li> <li>• Good pressure properties</li> <li>• Reduces wear</li> <li>• Resistant to ageing and oxidation</li> <li>• Waterproof</li> </ul>
	DIN 51 502: KF2K-30		
<b>OKS 472</b>	<b>Low-Temperature Grease for Food Processing Technology</b>		<ul style="list-style-type: none"> <li>• Lubrication of rolling and friction bearings with minimal bearing play and high speeds, at low temperatures as well as low coasting torques</li> <li>• Functionality of the lubricating film up to -70 °C</li> <li>• Reduces wear</li> <li>• Good resistance to ageing and oxidation</li> <li>• For bearings in cold storage houses, ice factories, etc.</li> </ul>
	DIN 51 502: KHC1K-40		

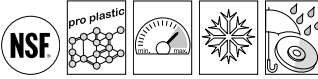
## Greases

Properties / Approvals	Main Components	Technical Data	Packaging
	red-brown EP additive mineral oil lithium soap	Operating temperature: -20 °C → +120 °C NLGI grade: 2 DN factor (dm x n): 400,000 mm/min Base oil viscosity (40 °C): 185 mm <sup>2</sup> /s Four-ball test rig (welding load): 2,600 N	120 cm <sup>3</sup> CL-cartridge 400 ml cartridge 1 kg tin 5 kg hobbock 25 kg hobbock
	brownish-transparent Mo <sub>x</sub> -Active adhesion improver synthetic oil	Operating temperature: -30 °C → +200 °C NLGI grade: not applicable DN factor (dm x n): not applicable Base oil viscosity (40 °C): 300 mm <sup>2</sup> /s Four-ball test rig (welding load): 2,400 N	1 l tin 5 l canister 25 l canister 200 l drum 400 ml aerosol*
	black carbon polyalphaolefin (PAO) lithium soap	Operating temperature: -40 °C → +150 °C NLGI grade: 2 DN factor (dm x n): 1,000,000 mm/min Base oil viscosity (40 °C): 150 mm <sup>2</sup> /s Four-ball test rig (welding load): n.a. Specific resistivity: max. 10,000 Ω*cm	400 ml cartridge 1 kg tin
 NSF H1 Reg. No. 135591	colourless synthetic oil inorganic thickener	Operating temperature: -25 °C → +150 °C NLGI grade: n.a. DN factor (dm x n): n.a. Base oil viscosity (40 °C): 1,700 mm <sup>2</sup> /s Four-ball test rig (welding load): n.a.	1 kg tin 5 kg hobbock
 NSF H1 Reg. No. 131380 Tested for beer foam compatibility	colourless-transparent polyalphaolefin (PAO) inorganic thickener	Operating temperature: -25 °C → +150 °C NLGI grade: 2 DN factor (dm x n): n.a. Base oil viscosity (40 °C): 400 mm <sup>2</sup> /s Four-ball test rig (welding load): n.a.	1 kg tin
 OKS 470: NSF H2 Reg. No. 137707	white white solid lubricants mineral oil lithium soap	Operating temperature: -30 °C → +120 °C NLGI grade: 2 DN factor (dm x n): 300,000 mm/min Base oil viscosity (40 °C): approx. 110 mm <sup>2</sup> /s Four-ball test rig (welding load): 3,600 N	80 ml tube 400 ml cartridge 1 kg tin 5 kg hobbock 25 kg hobbock 180 kg drum 400 ml aerosol*
 NSF H1 Reg. No. 135749	white polyalphaolefin (PAO) ester aluminium-complex soap	Operating temperature: -45 °C → +120 °C NLGI grade: 1 DN factor (dm x n): 800,000 mm/min Base oil viscosity (40 °C): 30 mm <sup>2</sup> /s Four-ball test rig (welding load): n.a.	400 ml cartridge 1 kg tin 5 kg hobbock 25 kg hobbock

## GREASES FOR LONG-TERM LUBRICATION UNDER CRITICAL OPERATION CONDITIONS

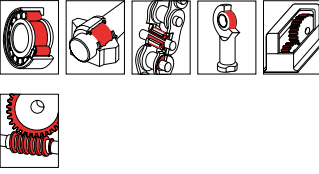
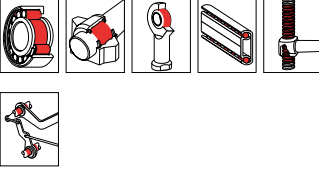
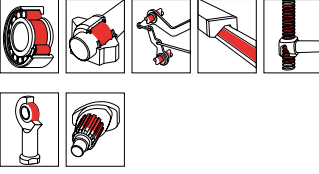
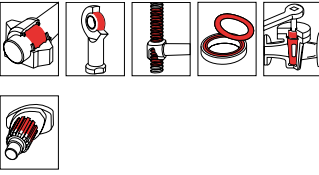
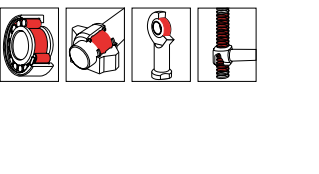

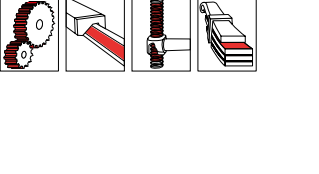



### Greases

Product	Designation	Fields of Application	Purpose
<b>OKS 473</b>	<b>Fluid Grease for Food Processing Technology</b>  DIN 51 502: KPHC00K-40		<ul style="list-style-type: none"> <li>• For closed gears, rolling and friction bearings, joints or chains if grease lubrication is provided for</li> <li>• Also suitable for higher speed, minimal bearing play or slight gear clearance</li> <li>• Reduces wear, waterproof</li> <li>• Can be conveyed well using central lubricating systems</li> </ul>
<b>OKS 475</b>	<b>High-Performance Grease</b>  DIN 51 502: KFHC2K-60		<ul style="list-style-type: none"> <li>• For bearings with minimal bearing play and high speeds, at low and high temperatures and for bearings with low coasting torque</li> <li>• Good wear protection through PTFE</li> <li>• Lubrication of components made of glass fibre reinforced plastic</li> <li>• For fast-running bearings in the textile industry, in filling and packaging machines</li> </ul>
<b>OKS 476</b>	<b>Multipurpose Grease for Food Processing Technology</b>  DIN 51 502: KP2K-30		<ul style="list-style-type: none"> <li>• For rolling and friction bearings and other machine elements</li> <li>• Resistant to cold and hot water as well as disinfectants and cleaning agents</li> <li>• Resistance to oxidation</li> <li>• Reduces wear</li> <li>• Multipurpose grease for universal use in food processing technology</li> </ul>
<b>OKS 477</b>	<b>Valve Grease for Food Processing Technology</b>  DIN 51 502: MHC3N-10		<ul style="list-style-type: none"> <li>• Sealing lubrication of adapted sliding surfaces</li> <li>• Lubrication of plastics and elastomers</li> <li>• Lubrication of slow-running bearings</li> <li>• Highly adhesive, seals well</li> <li>• Resistant to water and steam</li> <li>• Does not affect the quality properties of beer foam</li> <li>• Can also be used as sealing grease</li> </ul>
<b>OKS 479</b>	<b>High-Temperature Grease for Food Processing Technology</b>  DIN 51 502: KPHC1K-30		<ul style="list-style-type: none"> <li>• Lubrication of rolling and friction bearings at increased operating temperatures</li> <li>• Good adhesive strength on metal surfaces</li> <li>• Resistant to hot and cold water, water vapour, watery-alkaline and acidic disinfectants and cleaning agents</li> <li>• Good resistance to oxidation and ageing</li> <li>• For all sections of the food processing, beverage and pharmaceutical industries</li> </ul>
<b>OKS 480</b> <b>OKS 481*</b>	<b>Waterproof High-Pressure Grease for Food Processing Technology</b>  DIN 51 502: KPHC2P-30		<ul style="list-style-type: none"> <li>• For heavily loaded rolling and friction bearings in food processing technology</li> <li>• Excellent resistance to hot and cold water as well as disinfectants and cleaning agents</li> <li>• Excellent corrosion protection</li> <li>• High shear, temperature and oxidation stability</li> </ul>
<b>OKS 490</b>	<b>Toothed Gearing Grease, sprayable</b>  DIN 51 502: OGPFO5-30		<ul style="list-style-type: none"> <li>• For gears with highest pressures and high circumferential speeds</li> <li>• Lubrication of guides and slide rails</li> <li>• Excellent pressure resistance through EP additives and solid lubricants</li> <li>• Protection of the tooth flanks, also at long relubrication intervals</li> </ul>

**ChronoLube**  
System



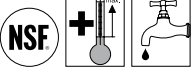
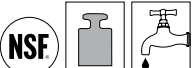



**ChronoLube**  
System

## Greases

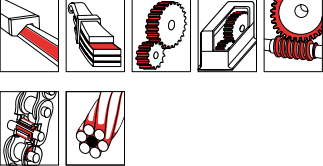

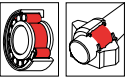

Properties / Approvals	Main Components	Technical Data	Packaging
 NSF H1 Reg. No. 140485	light yellow polyalphaolefin (PAO) aluminium-complex soap	Operating temperature: -45 °C → +120 °C NLGI grade: 0-00 DN factor (dm x n): 500,000 mm/min Base oil viscosity (40 °C): 160 mm <sup>2</sup> /s	1 kg tin 5 kg hobbock 25 kg hobbock
 NSF H2 Reg. No. 137708	beige PTFE polyalphaolefin (PAO) lithium soap	Operating temperature: -60 °C → +120 °C NLGI grade: 2 DN factor (dm x n): 1,000,000 mm/min Base oil viscosity (40 °C): approx. 30 mm <sup>2</sup> /s Four-ball test rig (welding load): 2,000 N	400 ml cartridge 1 kg tin 5 kg hobbock 25 kg hobbock 170 kg drum
 NSF H1 Reg. No. 137619	white semi-synthetic oil aluminium-complex soap	Operating temperature: -30 °C → +110 °C NLGI grade: 2 DN factor (dm x n): 400,000 mm/min Base oil viscosity (40 °C): 240 mm <sup>2</sup> /s Four-ball test rig (welding load): 2,200 N	400 ml cartridge 1 kg tin 5 kg hobbock 25 kg hobbock 180 kg drum
 NSF H1 Reg. No. 135750 Tested for beer foam compatibility	beige polyalphaolefin (PAO) silicate	Operating temperature: -10 °C → +140 °C NLGI grade: 3 DN factor (dm x n): n.a. Base oil viscosity (40 °C): 1,600 mm <sup>2</sup> /s Four-ball test rig (welding load): n.a.	80 ml tube 1 kg tin 5 kg hobbock
 NSF H1 Reg. No. 135675	beige polyalphaolefin (PAO) aluminium-complex soap	Operating temperature: -35 °C → +120 °C/+160 °C NLGI grade: 1 DN factor (dm x n): 500,000 mm/min Base oil viscosity (40 °C): 360 mm <sup>2</sup> /s	120 cm <sup>3</sup> CL-cartridge 400 ml cartridge 1 kg tin 5 kg hobbock 25 kg hobbock
 OKS 480: NSF H1 Reg. No. 148971 OKS 481: NSF H1 Reg. No. 153878	cream-coloured polyalphaolefin (PAO) calcium sulphonate complex soap	Operating temperature: -30 °C → +160 °C NLGI grade: 2 DN factor (dm x n): 400,000 mm/min Base oil viscosity (40 °C): 100 mm <sup>2</sup> /s	120 cm <sup>3</sup> CL-cartridge 400 ml cartridge 1 kg tin 5 kg hobbock 25 kg hobbock 400 ml aerosol*
	black graphite (ultra fine) EP additive mineral oil aluminium soap	Operating temperature: -30 °C → +220 °C NLGI grade: 0 DN factor (dm x n): n.a. Base oil viscosity (40 °C): 1,000 mm <sup>2</sup> /s Four-ball test rig (welding load): approx. 6,500 N FZG damage level: power level >12	1 kg tin 5 kg hobbock 25 kg hobbock 180 kg drum

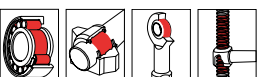
## GREASES FOR LONG-TERM LUBRICATION UNDER CRITICAL OPERATION CONDITIONS

### Greases

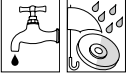

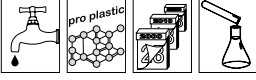
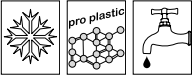
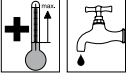
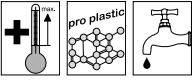

Product	Designation	Fields of Application	Purpose
<b>OKS 491</b>	Open Gear Spray, dry		<ul style="list-style-type: none"> <li>• Dry lubrication of slowly-turning, open pinion gears, steel cables etc. subjected to high pressures, dust or corrosive influences, such as outdoor weathering</li> <li>• Prevents adhesion of dust and dirt</li> </ul>
<b>OKS 495</b>	Adhesive Lubricant  DIN 51 502: OGPFS-30		<ul style="list-style-type: none"> <li>• Priming of heavily loaded tooth flanks and sliding surfaces</li> <li>• Run-in lubrication to avoid damage</li> <li>• Excellent pressure resistance</li> <li>• Lubrication of jackscrews in the motor vehicle and train technology</li> <li>• Gear rack lubrication in conveying equipment</li> </ul>
<b>OKS 1110</b> <b>OKS 1111*</b>	Multi-Silicone Grease  DIN 51 502: MSI3S-40		<ul style="list-style-type: none"> <li>• For fittings, seals and plastic parts</li> <li>• Resistant to media</li> <li>• Excellent compatibility to plastic</li> <li>• No drying out or bleeding</li> <li>• Highly adhesive, tasteless and odourless</li> <li>• Silicone grease for a broad range of applications</li> </ul>
<b>OKS 1112</b>	Silicone Grease for Vacuum Valves  DIN 51 502: MSI3S-30		<ul style="list-style-type: none"> <li>• For slide valves and valves</li> <li>• Excellent media resistance, e.g. to cold and hot water, acetone, ethanol, ethylene glycol, glycerin and methanol</li> <li>• Adheres and seals well</li> <li>• For use in vacuum plants and laboratory equipment</li> </ul>
<b>OKS 1133</b>	Low-Temperature Silicone Grease  DIN 51 502: KSI2S-70		<ul style="list-style-type: none"> <li>• Lubrication of rolling and friction bearings, bowden cables and fittings</li> <li>• Neutral with regard to plastics and elastomers</li> <li>• Lubrication of motors, drives, control systems under arctic conditions</li> </ul>
<b>OKS 1140</b>	Extreme-Temperature Silicone Grease  DIN 51 502: KFSI2U-20		<ul style="list-style-type: none"> <li>• For slow-running machine elements at extremely high temperatures</li> <li>• Minimal evaporation losses</li> <li>• For bearings at kilns, hardening furnaces, bakery machines, drying tunnels, foundry machines, boiler firing systems, plastics processing machines or welding and soldering machines etc.</li> </ul>
<b>OKS 1144</b>	Universal Silicone Grease  DIN 51 502: KSI2S-40		<ul style="list-style-type: none"> <li>• For bearings at changing temperatures and medium speeds</li> <li>• Good resistance to oxidation and ageing</li> <li>• Neutral with regard to plastics and elastomers</li> <li>• Lubrication of smaller bearings, e.g. of turbo-superchargers, blowers, water pumps, washing machines and driers</li> </ul>
<b>OKS 1149</b>	Silicone Grease, with PTFE  DIN 51 502: KFSI2-3R-50		<ul style="list-style-type: none"> <li>• Lubrication of plastic/plastic, plastic/metal, and elastomer/metal combinations at low to medium bearing loads and speeds</li> <li>• Use in a broad temperature range and good low temperature conditions</li> <li>• High oxidation stability</li> <li>• Excellent corrosion protection</li> </ul>

## Greases

Properties / Approvals	Main Components	Technical Data	Packaging
	black graphite bitumen mineral oil natural resins solvent	Operating temperature: -30 °C → +100 °C	400 ml aerosol
	black graphite EP additive mineral oil synthetic oil aluminium-complex soap	Operating temperature: -40 °C → +200 °C NLGI grade: 1 DN factor (dm x n): n.a. Base oil viscosity (40 °C): 500 mm <sup>2</sup> /s Four-ball test rig (welding load): 4,200 N FZG damage level: power level >12	1 kg tin 5 kg hobbock 25 kg hobbock
 <p>OKS 1110: NSF H1 Reg. No. 124381            KTW TZW: KA 0432/15            ACS: 17 CLP NY 015</p>	transparent silicone oil inorganic thickener	Operating temperature: -40 °C → +200 °C NLGI grade: 3 DN factor (dm x n): not applicable Base oil viscosity (40 °C): 9,500 mm <sup>2</sup> /s Four-ball test rig (welding load): not applicable	4 g tube 10 ml tube 80 ml tube 400 ml cartridge 500 g tin 1 kg tin 5 kg/25 kg hobbock 180 kg drum 400 ml aerosol*
	transparent silicone oil inorganic thickener	Operating temperature: -30 °C → +200 °C NLGI grade: 3 DN factor (dm x n): n.a. Base oil viscosity (40 °C): 100,000 mm <sup>2</sup> /s Evaporation loss (24h/200 °C): <3.0 percent in weight	500 g tin 5 kg hobbock 25 kg hobbock
	beige silicone oil lithium soap	Operating temperature: -73 °C → +200 °C NLGI grade: 2 DN factor (dm x n): 200,000 mm/min Base oil viscosity (40 °C): 100 mm <sup>2</sup> /s Four-ball test rig (welding load): 1,200 N	80 ml tube 500 g tin 5 kg hobbock 25 kg hobbock
	black silicone oil special carbon black	Operating temperature: -20 °C → +290 °C NLGI grade: 2 DN factor (dm x n): 75,000 mm/min Base oil viscosity (40 °C): 100 mm <sup>2</sup> /s Four-ball test rig (welding load): 2,100 N	500 g tin 5 kg hobbock 25 kg hobbock
	beige silicone oil lithium soap	Operating temperature: -40 °C → +200 °C NLGI grade: 2 DN factor (dm x n): 300,000 mm/min Base oil viscosity (25 °C): 125 mm <sup>2</sup> /s Four-ball test rig (welding load): 1,100 N	500 g tin 5 kg hobbock 25 kg hobbock
	white PTFE silicone oil lithium-complex soap	Operating temperature: -50 °C → +180 °C NLGI grade: 2-3 Base oil viscosity (25 °C): 200 mm <sup>2</sup> /s	400 ml cartridge 500 g tin 5 kg hobbock 25 kg hobbock

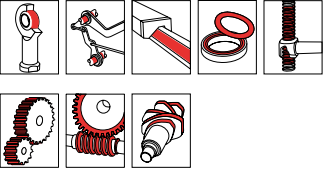
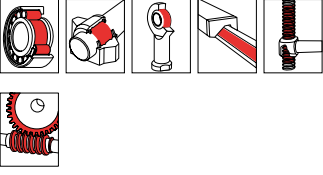

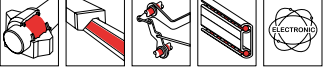

## GREASES FOR LONG-TERM LUBRICATION UNDER CRITICAL OPERATION CONDITIONS

### Greases

Product	Designation	Fields of Application	Purpose
<b>OKS 1155</b>	<b>Adherent Silicone Grease</b>  DIN 51 502: MSI2R-60		<ul style="list-style-type: none"> <li>• For sliding points between rubber and metals or plastics at low speeds</li> <li>• Excellent resistance to oxidation and ageing</li> <li>• Neutral with regard to plastics and elastomers</li> <li>• Highly adhesive. Seals well</li> <li>• For O-rings in pneumatic systems of brake systems</li> </ul>
<b>OKS 4100</b>	<b>MoS<sub>2</sub> Extreme Pressure Grease</b>  DIN 51 502: KPF2K-20		<ul style="list-style-type: none"> <li>• For slow-running rolling and friction bearings at very high, also shock-type loads</li> <li>• Good emergency running properties through MoS<sub>2</sub> sliding film</li> <li>• Excellent wear protection</li> <li>• Good water resistance, also during high quantities of water</li> <li>• Highly adhesive</li> <li>• For harsh operating conditions, e.g. in stone crushers</li> </ul>
<b>OKS 4200</b>	<b>Synthetic High-Temperature Bearing Grease with MoS<sub>2</sub></b>  DIN 51 502: KHCF2R-10		<ul style="list-style-type: none"> <li>• Long-term lubrication of rolling and friction bearings subjected to high temperatures</li> <li>• Extremely impact and pressure-resistant</li> <li>• Excellent wear protection</li> <li>• Functionally reliable across a wide temperature range</li> <li>• For fans, blowers, autoclaves, drying ovens, systems in metallurgical works and steelworks</li> </ul>
<b>Mo<sub>x</sub>-Active</b>	DIN 51 502: KHCF2R-10		
<b>OKS 4210</b>	<b>Extreme Temperature Grease</b>  DIN 51 502: KFFK2U-20		<ul style="list-style-type: none"> <li>• Long-term lubrication of rolling and friction bearings subjected to extremely high temperatures</li> <li>• Resistant to water, steam and chemicals</li> <li>• Excellent wear protection</li> <li>• Excellent plastic and elastomer compatibility</li> <li>• For bearings in burn-in and drying furnaces, boiler plants, roller and conveyor rollers in continuous furnaces</li> </ul>
<b>OKS 4220</b>	<b>Extreme-Temperature Bearing Grease</b>  DIN 51 502: KFFK2U-20		<ul style="list-style-type: none"> <li>• Long-term lubrication of rolling and friction bearings</li> <li>• Excellent temperature resistance</li> <li>• Excellent media resistance</li> <li>• Excellent plastic and elastomer compatibility</li> <li>• Excellent water, steam resistance</li> <li>• Excellent wear protection</li> </ul>
<b>OKS 4240</b>	<b>Special Grease for Ejector Pins</b>  DIN 51 502: MFFK2U-20		<ul style="list-style-type: none"> <li>• Long-term lubrication of rolling and friction bearings at extremely high temperatures and aggressive media</li> <li>• Resistant to plastics or elastomers</li> <li>• Excellent temperature resistance</li> <li>• For the lubrication of ejector pins in the plastics industry</li> </ul>
<b>OKS VP980</b>	<b>Lubricant for Electrical Switches</b>  DIN 51 502: MHC2P-50		<ul style="list-style-type: none"> <li>• Lubrication of electrical sliding contacts made of material pairs Cu/Cu, Cu/Ag and plastic/plastic within a broad temperature range</li> <li>• Use as damping grease for automobile switches, at grease-lubricated small gears, at load circuit-breakers in medium-voltage systems</li> <li>• Resistant to water vapour as well as hot and cold water</li> <li>• Noise-damping, oxidation-resistant, wear-resistant, ageing-resistant</li> </ul>

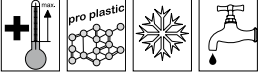

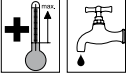
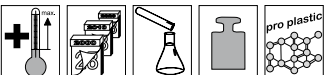
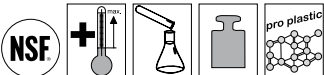
## Greases

Properties / Approvals	Main Components	Technical Data	Packaging
	beige silicone oil ester lithium soap	Operating temperature: -65 °C → +175 °C NLGI grade: 2 DN factor (dm x n): n.a. Base oil viscosity (40 °C): 100 mm <sup>2</sup> /s Four-ball test rig (welding load): n.a.	500 g tin 5 kg hobbock 25 kg hobbock
	black MoS <sub>2</sub> graphite mineral oil lithium-calcium soap	Operating temperature: -20 °C → +120 °C NLGI grade: 2 DN factor (dm x n): 100,000 mm/min Base oil viscosity (40 °C): 1,020 mm <sup>2</sup> /s Four-ball test rig (welding load): > 4,000 N	400 ml cartridge 5 kg hobbock 25 kg hobbock
	black MoS <sub>2</sub> Mo <sub>x</sub> -Active polyalphaolefin (PAO) special mineral oil bentonite	Operating temperature: -10 °C → +180 °C NLGI grade: 2 DN factor (dm x n): 400,000 mm/min Base oil viscosity (40 °C): 220 mm <sup>2</sup> /s Four-ball test rig (welding load): 2,600 N	400 ml cartridge 1 kg tin 5 kg hobbock 25 kg hobbock 180 kg drum
	white PTFE perfluoropolyether (PFPE)	Operating temperature: -20 °C → +280 °C NLGI grade: 2 DN factor (dm x n): 300,000 mm/min Base oil viscosity (40 °C): 510 mm <sup>2</sup> /s Four-ball test rig (welding load): 9,000 N	800 g cartridge 1 kg tin 5 kg hobbock 25 kg hobbock
 NSF H1 Reg. No. 124380	white PTFE perfluoropolyether (PFPE)	Operating temperature: -30 °C → +280 °C NLGI grade: 2 DN factor (dm x n): 300,000 mm/min Base oil viscosity (40 °C): 510 mm <sup>2</sup> /s Four-ball test rig (welding load): >10,000 N	40 ml tube 800 g cartridge 500 g tin 1 kg tin 5 kg hobbock 25 kg hobbock
	white PTFE perfluoropolyether (PFPE) inorganic thickener	Operating temperature: -20 °C → +300 °C NLGI grade: 2 DN factor (dm x n): 350,000 mm/min Base oil viscosity (40 °C): 440 mm <sup>2</sup> /s Four-ball test rig (welding load): 4,800 N	250 g Spender 1 kg tin
	beige Polyalphaolefine (PAO) Polyurea	Operating temperature: -50 °C → +160 °C NLGI grade: 2 Base oil viscosity (40 °C): 32 mm <sup>2</sup> /s	250 g tube

## DRY LUBRICANTS – THE ALTERNATIVE FOR SPECIAL APPLICATION CASES

### Dry Lubricants

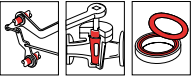
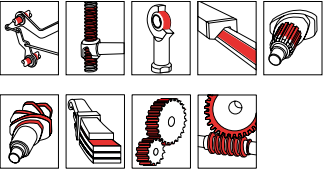
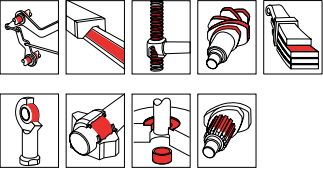
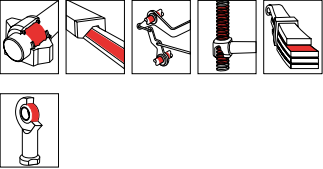
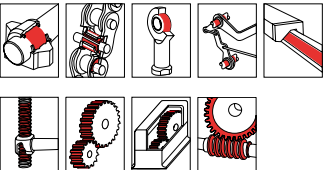
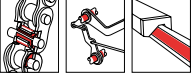
Product	Designation	Fields of Application	Purpose
<b>OKS 100</b>	MoS <sub>2</sub> Powder, high degree of purity		<ul style="list-style-type: none"> <li>• To improve the sliding properties of machine elements</li> <li>• Run-in lubricant in combination with oil or grease lubrication</li> <li>• Prevents friction and wear</li> <li>• Not electroconductive</li> <li>• For integration in plastics, seals and packings</li> </ul>
<b>OKS 110</b> <b>OKS 111*</b>	MoS <sub>2</sub> Powder, microsize		<ul style="list-style-type: none"> <li>• Run-in lubricant in combination with oils or greases</li> <li>• Not electroconductive</li> <li>• For pressing in bearings</li> <li>• Prevents friction and wear, even at high pressures</li> <li>• Good adhesion, even at extremely precision-machined surfaces</li> </ul>
<b>OKS 510</b> <b>OKS 511*</b>	MoS <sub>2</sub> Bonded Coating, fast-drying		<ul style="list-style-type: none"> <li>• Dry lubrication for temporary operation or long downtimes, industry environments and at low sliding speeds</li> <li>• Run-in lubricant in combination with oils or greases</li> <li>• Creates emergency-running properties</li> <li>• Dries at room temperature</li> </ul>
<b>OKS 521</b> <b>New</b>	MoS <sub>2</sub> Bonded Coating, air-hardening		<ul style="list-style-type: none"> <li>• Air-hardening bonded coating on MoS<sub>2</sub>-graphite basis</li> <li>• Dry lubrication of machine elements subject to high demands</li> <li>• Use in a broad temperature range at low to medium rotational speeds</li> <li>• Rapid curing at room temperature</li> <li>• Thin film layer</li> </ul>
<b>OKS 530</b>	MoS <sub>2</sub> Bonded Coating, water-based, air-drying		<ul style="list-style-type: none"> <li>• Lubrication of heavily loaded chains when oil and grease lubrication is no longer possible</li> <li>• Wear protection for increased service life</li> <li>• No adhesion of dust and dirt</li> <li>• Good adhesion to metal</li> <li>• Can be used under vacuum</li> <li>• Can be diluted with water in ratio of up to 1:1</li> </ul>
<b>OKS 536</b>	Graphite Bonded Coating, water-based, air-drying		<ul style="list-style-type: none"> <li>• Lubrication of heavily loaded chains when oil and grease lubrication is no longer possible</li> <li>• Can be sprayed onto hot surfaces</li> <li>• Use in a broad temperature range</li> <li>• Dries at room temperature</li> <li>• Spent sliding film can be topped up</li> <li>• Can be diluted with water in ratio of up to 1:5</li> </ul>



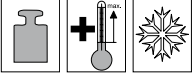
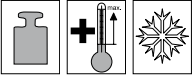
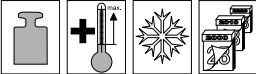
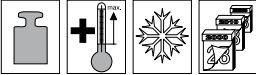
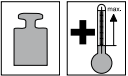
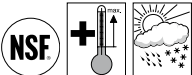

**Dry Lubricants**

Properties / Approvals	Main Components	Technical Data	Packaging
	grey-black $\text{MoS}_2$	Operating temperature: $-185^\circ\text{C} \rightarrow +450^\circ\text{C}$ (up to $+1,100^\circ\text{C}$ in vacuum, up to $+1,300^\circ\text{C}$ in inert gas) Thread friction: n.a. Particle size: $16.0 - 30.0 \mu\text{m}$ , max. $190.0 \mu\text{m}$	250 g tin 1 kg tin 5 kg hobbock 25 kg hobbock
	grey-black $\text{MoS}_2$ wax (*only aerosol)	Operating temperature: $-185^\circ\text{C} \rightarrow +450^\circ\text{C}$ (up to $+1,100^\circ\text{C}$ in vacuum, up to $+1,300^\circ\text{C}$ in inert gas) Particle size: $2.5 - 5.0 \mu\text{m}$ , max. $15.0 \mu\text{m}$	1 kg tin 5 kg hobbock 25 kg hobbock 400 ml aerosol*
	black $\text{MoS}_2$ graphite silicone resin solvent	Operating temperature: $-180^\circ\text{C} \rightarrow +450^\circ\text{C}$ Press-fit: $\mu = 0.07$ , no chatter	500 g tin 5 kg hobbock 25 kg hobbock 400 ml aerosol*
	black $\text{MoS}_2$ graphite polybutylene-titanate solvent	Operating temperature: $-180^\circ\text{C} \rightarrow +450^\circ\text{C}$ Processing temperature: approx. $20^\circ\text{C}$ Density ( $20^\circ\text{C}$ ): $1.05 \text{ g/ml}$	400 ml aerosol
	black $\text{MoS}_2$ graphite organic binder water alcohol	Operating temperature: $-35^\circ\text{C} \rightarrow +450^\circ\text{C}$ Press-fit: $\mu = 0.10$ , no chatter Thread friction (M10/8.8): $\mu = 0.05$	1 kg tin 5 kg canister 25 kg canister
	black graphite organic binder water	Operating temperature: $-35^\circ\text{C} \rightarrow +600^\circ\text{C}$ Press-fit: $\mu = 0.12$ , no chatter Thread friction: n.a.	5 kg canister 25 kg canister



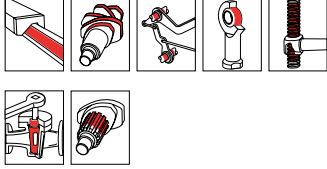
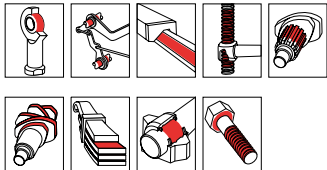
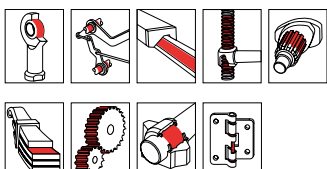
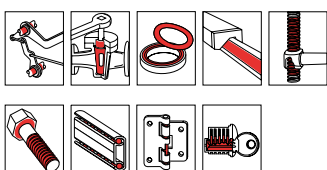



NSF H2 Reg. No. 130416

## DRY LUBRICANTS – THE ALTERNATIVE FOR SPECIAL APPLICATION CASES

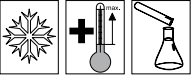
### Dry Lubricants

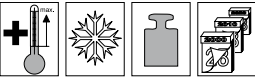
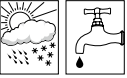

Product	Designation	Fields of Application	Purpose
<b>OKS 570</b> <b>OKS 571*</b>	PTFE Bonded Coating		<ul style="list-style-type: none"> <li>• Dry lubrication of sliding surfaces of different materials at low pressures, low speeds and in dusty environments</li> <li>• Prevents tribocorrosion</li> <li>• Dries at room temperature</li> <li>• No-soiling sliding and parting film</li> </ul>
<b>OKS 575</b>	PTFE Water Bonded Coating		<ul style="list-style-type: none"> <li>• For sliding surfaces made of different materials at low pressures, low speeds and in dusty environments</li> <li>• Avoids squeaking at differently hard materials</li> <li>• Dries at room temperature</li> <li>• Verifiable with UV indicator</li> <li>• Can be diluted with water</li> </ul>
<b>OKS 589</b>	MoS <sub>2</sub> PTFE Bonded Coating, thermosetting		<ul style="list-style-type: none"> <li>• Dry lubrication of sliding surfaces under heavy loads and low speeds</li> <li>• Prevents friction and wear</li> <li>• No adhesion of dust and dirt</li> <li>• Use in a broad temperature range</li> </ul>
<b>OKS 1300</b> <b>OKS 1301*</b>	Sliding Film, colourless		<ul style="list-style-type: none"> <li>• Thread coating</li> <li>• Sliding film for plastic, wood and metal</li> <li>• Dry sliding film fast to handling</li> <li>• Verifiable with UV indicator</li> <li>• Prevents seizing</li> <li>• For all screw materials</li> <li>• Broad range of uses, in particular for precoating small and mass-produced parts</li> </ul>
<b>OKS 1710</b>	Sliding Film for Screws, water-based concentrate		<ul style="list-style-type: none"> <li>• Thread coating, also for galvanic surfaces and VA screws, for controlled assembly</li> <li>• Dry sliding film fast to handling</li> <li>• Verifiable with UV indicator</li> <li>• Can be diluted with water in a ratio of up to 1:5</li> <li>• Economic precoating</li> </ul>
<b>OKS 1750</b>	Sliding Film for Wood Screws, water-based concentrate		<ul style="list-style-type: none"> <li>• Coating of threads with galvanised surfaces</li> <li>• Dry sliding film fast to handling</li> <li>• Verifiable with UV indicator</li> <li>• Can be diluted with water in a ratio of up to 1:5</li> <li>• In particular for chipboard screws</li> </ul>
<b>OKS 1765</b>	Sliding Film for Thread-Cutting Screws, water-based concentrate		<ul style="list-style-type: none"> <li>• Coating of thread-cutting screws made of high-alloy steels, galvanised and austenitic steels</li> <li>• Dry sliding film fast to handling</li> <li>• Prevents cold welding</li> <li>• Can be diluted with water in a ratio of up to 1:5</li> </ul>

### Dry Lubricants





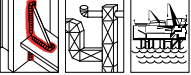
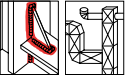
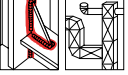
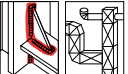

Properties / Approvals	Main Components	Technical Data	Packaging
	whitish PTFE silicone resin solvent UV-indicator (OKS 570)	Operating temperature: -180 °C → +260 °C Press-fit: $\mu = 0.07$ , no chatter Thread friction (M10/8.8): $\mu = 0.10$	500 ml tin 5 l hobbock 25 l hobbock 400 ml aerosol*
	whitish PTFE Acrylatcopolymer UV-indicator water	Operating temperature: -180 °C → +150 °C/+250 °C Press-fit: n.a. Thread friction (M10/8.8): not applicable	5 kg canister
	matt black MoS <sub>2</sub> graphite PTFE epoxy resin solvent	Operating temperature: -70 °C → +250 °C Press-fit: $\mu = 0.07$ , no chatter Thread friction (M10/8.8): $\mu = 0.08$	5 kg hobbock
	colourless UV-indicator (OKS 1300) synthetic wax solvent	Operating temperature: -60 °C → +100 °C Press-fit: n.a. Thread friction (M10/8.8): $\mu = 0.08 - 0.10$	5 l canister 25 l canister 200 l drum 400 ml aerosol*
	milky-white UV-indicator corrosion protection inhibitor synthetic wax water isopropanol	Operating temperature: > +60 °C Press-fit: n.a. Thread friction (M10/8.8): $\mu = 0.08 - 0.14$ (depending on concentration and surface)	5 l canister 25 l canister 200 l drum
	yellowish UV-indicator corrosion protection inhibitor synthetic wax water isopropanol	Operating temperature: > +70 °C Press-fit: n.a. Thread friction (M10/8.8): $\mu = 0.08 - 0.14$ (depending on concentration and surface)	25 l canister
	milky-white corrosion protection inhibitor synthetic wax water isopropanol	Operating temperature: > +70 °C Press-fit: n.a. Thread friction (M10/8.8): $\mu = 0.06 - 0.15$ (depending on concentration and surface)	5 l canister 25 l canister

## CORROSION PROTECTION FOR RELIABLE PRESERVATION DURING STORAGE AND SHIPPING

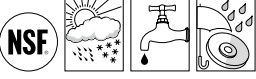
### Corrosion Protection



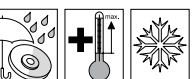



Product	Designation	Fields of Application	Purpose
<b>OKS 2100</b> <b>OKS 2101*</b>	Protective Film for Metals		<ul style="list-style-type: none"> <li>• Temporary wax-based corrosion protection film for storage and shipping of machine parts with bare metal surfaces</li> <li>• Suitable for all climatic zones</li> <li>• Non-tacky, transparent film</li> <li>• Easy to remove</li> <li>• Good compatibility with lubricants</li> </ul>
<b>OKS 2200</b>	Water-based Corrosion Protection, VOC-free		<ul style="list-style-type: none"> <li>• Temporary corrosion protection for all bare metal surfaces under environmental influences such as humidity, moisture, salty atmosphere or industrial atmospheres</li> <li>• Environmentally friendly VOC-free product based on water</li> <li>• Can be removed easily with warm water and water-based cleaners, such as OKS 2650</li> <li>• For use at storage and transportation of metal semi-finished products, spare parts, forms and machines</li> </ul>
<b>OKS 2300</b> <b>OKS 2301*</b>	Mould Protector		<ul style="list-style-type: none"> <li>• Temporary corrosion protection film for bare metal surfaces</li> <li>• Green colouration for checking</li> <li>• Suitable for all climatic zones</li> <li>• Displaces water</li> <li>• Easy to remove</li> <li>• Good compatibility with lubricants</li> <li>• For use at storage and dispatch of machine parts</li> </ul>
<b>OKS 2511</b>	Zinc Coating		<ul style="list-style-type: none"> <li>• Cathodic corrosion protection based on highly pure zinc powder for ferrous metals</li> <li>• For touching up galvanised surfaces</li> <li>• Also suitable as adhesive primer for coating systems</li> <li>• Fast-drying</li> <li>• For use in steel construction work in air conditioning technology</li> </ul>
<b>OKS 2521</b>	Gloss Zinc		<ul style="list-style-type: none"> <li>• Decorative corrosion protection based on zinc and aluminium powder for ferrous metals</li> <li>• For touching up hot-galvanised surfaces</li> <li>• Can be welded through</li> <li>• Abrasion resistant</li> <li>• Can be painted over</li> <li>• Fast-drying</li> </ul>
<b>OKS 2531</b>	Alu-Metallic		<ul style="list-style-type: none"> <li>• Decorative corrosion protection based on aluminium powder for metals and other solid materials</li> <li>• For touching up hot-galvanised surfaces</li> <li>• Fast-drying</li> <li>• Abrasion resistant</li> <li>• Protects vehicle exhaust systems</li> </ul>
<b>OKS 2541</b>	Stainless Steel Protection		<ul style="list-style-type: none"> <li>• Resistant protective and decorative coating with stainless steel pigments for all materials</li> <li>• Highly adhesive</li> <li>• Impact, abrasion and scratch resistant</li> <li>• Fast-drying</li> <li>• Optimal when combined with OKS 2511</li> </ul>

## Corrosion Protection

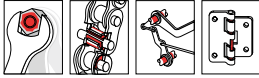
Properties / Approvals	Main Components	Technical Data	Packaging
 <p>OKS 2100: NSF H2 Reg. Nr. 142256</p>	light-coloured synthetic wax corrosion protection additive solvent	Operating temperature: $-40^{\circ}\text{C} \rightarrow +70^{\circ}\text{C}$ Salt spray test: > 1,000 h with 50 $\mu\text{m}$ layer thickness Optimal layer thickness: 50 $\mu\text{m}$	5 l canister 25 l canister 200 l drum 400 ml aerosol*
	light-coloured synthetic wax corrosion protection additive water	Operating temperature: $-40^{\circ}\text{C} \rightarrow +70^{\circ}\text{C}$ Salt spray test: > 1,000 h with 30 $\mu\text{m}$ layer thickness Optimal layer thickness: > 30 $\mu\text{m}$	1 l bottle 5 l canister 25 l canister
	greenish synthetic wax corrosion protection additive solvent	Operating temperature: $-40^{\circ}\text{C} \rightarrow +70^{\circ}\text{C}$ Salt spray test: > 1,000 h with 50 $\mu\text{m}$ layer thickness Optimal layer thickness: > 10 $\mu\text{m}$	5 l canister 25 l canister 200 l drum 400 ml aerosol*
	zinc grey purest zinc powder synthetic resin mixture solvent mixture	Operating temperature: up to $+400^{\circ}\text{C}$ Salt spray test: 700 h with 70 $\mu\text{m}$ layer thickness Optimal layer thickness: 60 – 80 $\mu\text{m}$	400 ml aerosol
	aluminium-coloured purest zinc powder purest aluminium powder synthetic resin solvent mixture	Operating temperature: up to $+240^{\circ}\text{C}$ Salt spray test: 240 h with 80 – 100 $\mu\text{m}$ layer thickness Optimal layer thickness: 30 – 40 $\mu\text{m}$	400 ml aerosol
	aluminium-coloured purest aluminium powder hydrocarbon resin solvent mixture	Operating temperature: $-30^{\circ}\text{C} \rightarrow +400^{\circ}\text{C}$ (briefly up to $+800^{\circ}\text{C}$ ) Salt spray test: > 600 h with 50 $\mu\text{m}$ layer thickness Optimal layer thickness: 50 $\mu\text{m}$	400 ml aerosol
	bright metallic stainless-steel pigments acrylic resin solvent mixture	Operating temperature: up to $+100^{\circ}\text{C}$ Optimal layer thickness: 20 $\mu\text{m}$	400 ml aerosol

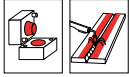











## MAINTENANCE PRODUCTS FOR ONGOING SERVICE

### Maintenance Products

Product	Designation	Fields of Application	Purpose
<b>OKS 611</b> <i>New Formulation!</i>	Rust Remover with MoS <sub>2</sub>		<ul style="list-style-type: none"> <li>• For destruction-free dismantling of seized or rusted-in machine elements</li> <li>• Excellent creep properties</li> <li>• Displaces moisture</li> <li>• Good sliding properties through MoS<sub>2</sub></li> <li>• Universal rust dissolver for industry, workshop and maintenance applications</li> </ul>
<b>OKS 621</b>	(F)Rost Breaker		<ul style="list-style-type: none"> <li>• Destruction-free dismantling of seized or rusted-in machine elements</li> <li>• Breaks open corrosion layers by cooling down to -40 °C</li> <li>• Penetration of creep oil into microsize cracks</li> <li>• Fast-acting rust dissolver for industry, workshop and maintenance applications</li> </ul>
<b>OKS 1360</b> <b>OKS 1361*</b>	Silicone Release Agent		<ul style="list-style-type: none"> <li>• Parting agent and lubricant for use in processing plastics</li> <li>• Chemically neutral</li> <li>• Solvent-free</li> <li>• Displaces water</li> <li>• Fitting aid for rubber profiles</li> <li>• Lubrication of cutting edges</li> <li>• Care and impregnation of plastic surfaces and textiles (OKS 1361)</li> </ul>
<b>OKS 1510</b> <b>OKS 1511*</b>	Release Agent, silicone-free		<ul style="list-style-type: none"> <li>• Silicone-free parting agent for arc and inert-gas arc welding</li> <li>• No burning on of weld spatters</li> <li>• Increases torch service life</li> <li>• Highly-effective mould release agent for processing plastics</li> <li>• Universal solvent-based welding spray</li> </ul>
<b>OKS 1600</b> <b>OKS 1601*</b>	Spatter Release, water-based concentrate		<ul style="list-style-type: none"> <li>• Environmentally friendly, water-based parting agent for arc and inert-gas arc welding</li> <li>• No burning on of weld spatters</li> <li>• Increases torch service life</li> <li>• Can be removed residue-free</li> <li>• Universal, silicone-free, welding parting-agent concentrate</li> </ul>
<b>OKS 2711</b>	Refrigerating Spray		<ul style="list-style-type: none"> <li>• Rapid undercooling of smaller surfaces and parts down to -45 °C</li> <li>• Simulation of cold-start conditions on motor vehicle engines</li> <li>• For locating thermally-related interruptions</li> <li>• Protects adjacent areas during soldering and welding</li> <li>• Easier mounting with interference fits</li> </ul>
<b>OKS 2731</b>	Compressed-Air Spray		<ul style="list-style-type: none"> <li>• Removal of loose dirt particles at inaccessible points</li> <li>• Dry, oil-free pressurised gas mixture</li> <li>• Evaporates quickly and residue-free</li> <li>• For maintenance work in electronics and precision mechanics, on optical devices and all types of office machines</li> </ul>





### Maintenance Products

Properties / Approvals	Main Components	Application tips	Packaging
	green-black mineral oil MoS <sub>2</sub> solvent	For optimum effectiveness, clean soiling from corresponding area mechanically. Spray on generously and allow to soak. Repeat as necessary. Operating temperature: -30 °C → +60 °C / 150 °C (After evaporation of the solvent) Viscosity (40 °C): > 3 mm <sup>2</sup> /s.	400 ml aerosol
	light-coloured mineral oil solvent	Before applying, remove coarse soiling. Shake can before use. Spray on from distance of 10 – 15 cm and allow to soak in for approx. 1 – 2 min. Repeat as necessary. Operating temperature: -10 °C → +40 °C.	400 ml aerosol
     OKS 1361: NSF H1 Reg. No. 129481	colourless silicone oil	For optimum effect, apply or spray on an even, thin layer of the product and avoid excessive lubrication. Operating temperature: -50 °C → +200 °C	1 l tin 5 l canister 25 l canister 400 ml aerosol*
 	yellowish vegetable base oil solvent	For optimum effect, clean surfaces mechanically and with OKS 2611. Spray on an even, thin coating to application area from a distance of 20 – 30 cm. We recommend carrying out a test before processing the workpieces further, for example through galvanising.	5 l canister 25 l canister 400 ml aerosol*
 	transparent natural greasy oil water	For optimum effect, clean surfaces mechanically and with OKS 2610/OKS 2611. Depending on application, dilute OKS 1600 with water in 1 : 5 ratio and apply an even thin coating.	5 l canister 25 l canister 400 ml aerosol*
 	colourless active and propellant gases	Spraying of cooled parts until desired temperature is reached. Do not use with voltage connected and keep away from ignition sources.	400 ml aerosol
	colourless active and propellant gases	Spray surface at shorter intervals from a distance of approx. 10 cm. Do not shake can before use and hold vertically when spraying. Do not use with voltage connected and keep away from ignition sources.	400 ml aerosol



## MAINTENANCE PRODUCTS FOR ONGOING SERVICE

### Maintenance Products

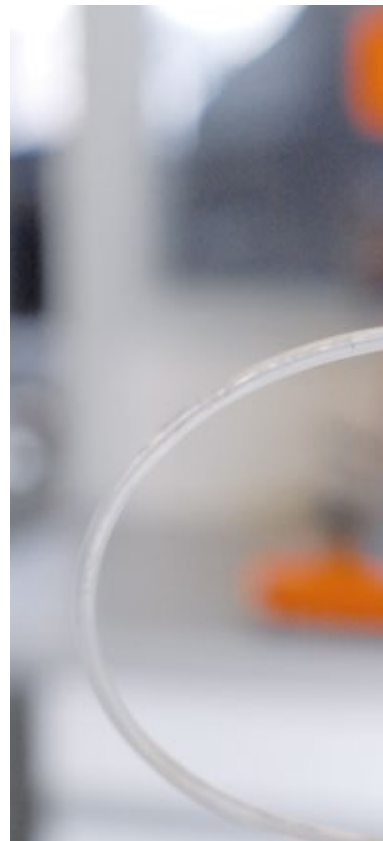
Product	Designation	Fields of Application	Purpose
<b>OKS 2800</b> <b>OKS 2801*</b>	Leak Detector		<ul style="list-style-type: none"> <li>• Location of leaks on pressurised lines, fittings and containers</li> <li>• Formation of bubbles indicates loss of gas</li> <li>• For use on pneumatic, oxygen and gas systems as well as refrigerating machines</li> </ul>
<b>OKS 2811</b>	Leak Detector, frost-proof		<ul style="list-style-type: none"> <li>• Location of leaks on pressurised lines, fittings and containers down to <b>-15°C</b></li> <li>• Formation of bubbles indicates loss of gas</li> <li>• For use on pneumatic, oxygen and gas systems as well as refrigerating machines</li> </ul>
<b>OKS 2901</b>	Belt Tuning		<ul style="list-style-type: none"> <li>• Increases belt tension force</li> <li>• Prevents slip</li> <li>• Protects belt against drying out and wearing</li> <li>• Increases service life</li> <li>• Prevents squeaking</li> <li>• For universal use on all V-belts, round and flat belts</li> </ul>









### Maintenance Products

Properties / Approvals	Main Components	Application tips	Packaging
 <p>Approval under DIN DVGW Mark of conformity NG 5170AO0659</p>	<p>transparent active ingredients corrosion protection water</p>	<p>Wetting of area to be checked with air spray system, brush or by spraying on. Formation of bubbles indicates leaks. Protect against frost. When using on polyamide lines, wash off product with water afterwards. Operating temperature: 0 °C → +50 °C (DVGW).</p>	<p>5 l canister 25 l canister 400 ml aerosol*</p>
 <p>Approval under DIN DVGW Mark of conformity DG-5170CN0340</p>	<p>colourless active ingredients corrosion protection water</p>	<p>Wetting of area to be checked with hand sprayer, brush or by spraying on. Formation of bubbles indicates leaks. When using on polyamide lines, wash off with water afterwards. Operating temperature: -15 °C → +50 °C (DVGW).</p>	<p>400 ml aerosol</p>
	<p>yellowish adhesive oil solvent</p>	<p>For optimum adhesion, clean belt mechanically and with OKS 2611. Spray belt evenly. Allow to soak in for 30 min before operating. Repeat as necessary. Check compatibility with plastic before use. Operating temperature: up to +80 °C.</p>	<p>400 ml aerosol</p>









## CLEANERS FOR THOROUGH REMOVAL OF SOILING AND LUBRICANT RESIDUES

### Cleaners

Product	Designation	Fields of Application	Purpose
<b>OKS 2610</b> <b>OKS 2611*</b>	Universal Cleaner		<ul style="list-style-type: none"> <li>• For machine parts and surfaces with oily or greasy soiling</li> <li>• Evaporates quickly and residue-free</li> <li>• High cleaning power</li> <li>• Cleaner for lubrication and glueing points</li> </ul>
<b>OKS 2621</b>	Contact Cleaner		<ul style="list-style-type: none"> <li>• To remove soiling that can cause creepage currents</li> <li>• No running thanks to fast evaporation</li> <li>• For example, for cleaning distribution boards, switches, relays, potentiometers, plug-in connections, sliding and screw contacts</li> </ul>
<b>OKS 2631</b>	Multi-Foam Cleaner, Spray		<ul style="list-style-type: none"> <li>• Removes firmly adhering organic soiling such as nicotine, fat and silicone films</li> <li>• Cleans metals, plastics, glass and rubber in the gastronomy, office and vehicle fields gently and without leaving stripes</li> <li>• Ideally suitable for vertical surfaces</li> </ul>
<b>OKS 2650</b>	BIologic Industrial Cleaner, water-based concentrate		<ul style="list-style-type: none"> <li>• Aqueous cleaner for removing heavy oily, greasy and sooty soiling</li> <li>• Biodegradable</li> <li>• Good separation behaviour</li> <li>• Gentle to delicate surfaces</li> <li>• For universal use in industry, workshop and food processing technology</li> </ul>
<b>OKS 2660</b> <b>OKS 2661*</b>	Fast Cleaner		<ul style="list-style-type: none"> <li>• For machine parts and surfaces with oily or greasy soiling</li> <li>• Evaporates quickly and residue-free</li> <li>• High cleaning power</li> <li>• Ideal for preparation of bonded connections and cleaning of lubricating points</li> <li>• Brake cleaner</li> </ul>
<b>OKS 2670</b> <b>OKS 2671*</b>	Intensive Cleaner for the Food Processing Industry		<ul style="list-style-type: none"> <li>• For removing aged and gummy oil and grease residues</li> <li>• For dissolving silicone and adhesive residues</li> <li>• Evaporates quickly and residue-free</li> <li>• High cleaning action</li> <li>• Good compatibility to common plastics</li> <li>• For use in the food processing, livestock feed and pharmaceutical industries</li> </ul>
<b>OKS 2681</b>	Adhesive and Paint Remover		<ul style="list-style-type: none"> <li>• For the removal of stubborn impurities, such as residues of sealants, paints and adhesives, bitumen and tar splashes</li> <li>• Can be used on metal, stainless steel, glass, wood and ceramics</li> <li>• Can be washed off well with water after use</li> <li>• Low effect on climate</li> <li>• For use in industry, workshops and trade</li> </ul>

**Cleaners**

Properties / Approvals	Main Components	Application tips	Packaging
	colourless solvent mixture	Generously wet or spray the surfaces to be cleaned from a short distance and rub down with cloths if necessary. Then allow to dry at room temperature. Check resistance of plastics and paintwork before using.	5 l canister 25 l canister 25 l drum 200 l drum 500 ml aerosol*
	colourless solvent mixture	Switch off voltage and discharge electrostatic charging before use. Spray until desired cleanliness is achieved. Due to the wide variety of plastics used in electrical engineering, check plastics for corresponding resistance before use.	400 ml aerosol
 Stress crack test to DIN EN ISO 22088-3 passed	bluish anionic surfactants additives water	Shake can well before use. Spray on evenly from a distance of about 20 – 30 cm. Wipe off with a clean cloth. In the case of special coating check for compatibility.	400 ml aerosol
 NSF A1 Reg. No. 129003	red non-ionic surfactants silicates	Depending on the degree of soiling, can be diluted with water to a maximum of 1:10. pH value: 11.0 (concentrate)	500 ml pump sprayer 5 l canister 25 l canister 200 l drum
	colourless solvent mixture	Generously spray the surfaces to be cleaned from a short distance and rub down with cloths if necessary. Then allow to dry at room temperature. Check resistance of plastics and paintwork before using.	25 l canister 56 l drum 600 ml aerosol*
 OKS 2670: NSF K1 / K3 Reg. No. 149997 OKS 2671: NSF K1 / K3 Reg. No. 149998	colourless solvent mixture	Generously wet the surfaces to be cleaned and, if necessary, support the cleaning process through rubbing down. Subsequently allow to dry completely at room temperature. Do not use at surfaces made of EPDM elastomers and silicones. In case of sensitive materials check the suitability before use. Caution: Observe the specifications of the NSF when used in the food processing industry.	5 l canister 25 l canister 200 l drum 400 ml aerosol*
	colourless solvent mixture	Shake can well before use. Spray onto the surfaces to be cleaned and, depending on the degree of soiling, allow it to react for a longer period. Subsequently wipe off with a moist cloth. Check resistance of plastics and painted surfaces before using.	400 ml aerosol

## The economic and ecological alternative to the spray can

The pressure spray system consists of the Airspray can and a unit for filling the can with product and compressed air. The air serves as a harmless propellant gas. OKS products such as oils and cleaning agents can be processed by means of corresponding valves and spray heads.

### Avoiding waste – reducing costs

The OKS Airspray-System prevents waste and reduces costs. Disposal cost that would arise if spray cans were used, are reduced. A small investment in environmental protection that pays off rapidly.

### Robust and safe

The indestructible Airspray can was developed specially for rough usage in industrial operation and in workshops. In order to ensure that the specified hazardous substances marking and a clear assignment of the filled can to the product are fulfilled, corresponding product labels are provided for download at [www.oks-germany.com](http://www.oks-germany.com).

### Proven and favourable

Whether in the workshop or in industrial maintenance. For more than 15 years the Airspray-System has proven itself as the trouble-free and inexpensive alternative to the spray can.

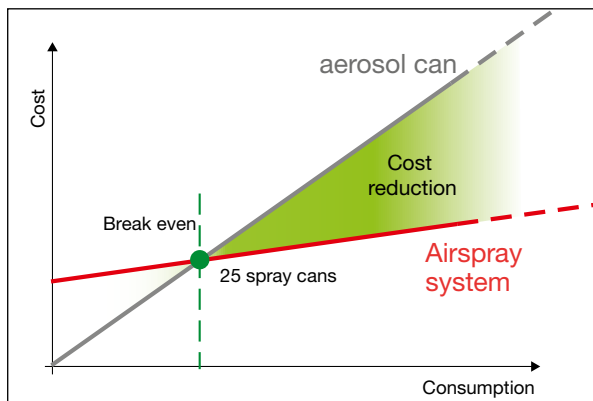

Cost efficiency calculation for OKS 2610 Universal Cleaner

### OKS Airspray filling station in comparison to conventional spray can

A comparison of the cost effectiveness of the OKS Airspray-System with the use of conventional OKS 2611 spray cans shows that a cost reduction through the use of the OKS Airspray-System already results after the use of 25 spray cans.



## System components and products

### Filling station for use in workshops

The filling station allows simple filling of the Airspray can with compressed air. It is suitable for fixed mounting for example near the product location or at the workplace.

How to do it: Fill the product into the Airspray can, insert the rising tube with adapter, place the valve with spray head onto the adapter and screw handtight with the union nut. Place the can with the valve on the filling station, press down for approx. 2 s. Ready to spray.



### Automatic filling unit for industrial users

The automatic filling unit allows filling of the Airspray can with product and compressed air in one pass.

How to do it: The automatic filling unit is connected to the product container through the suction line. The Airspray can is pressed into the "Active substance-air tapping point" (red) for filling. The can can be filled or refilled with compressed air through the additional "Air tapping point" (black).



### Airspray spray sets

A Universal spray set which is not product-specific allows the perfect usage of the Airspray can with the applicable OKS products. This spray set encompasses three different spray heads which differ in their spray pattern and spray rate and can thus be selected flexibly to ideally suit the respective application conditions. The spray heads are fitted with Viton seals to achieve high application stability. To allow clear allocation of the filled can to the OKS product used the corresponding labels can be downloaded under [www.oks-germany.com](http://www.oks-germany.com). The blank label templates for printing are enclosed with the spray set.

### Drain cocks

Reusable drain cocks for filling into the Airspray can without dripping or leaking, suitable for all 5 l and 25 l OKS plastic canisters.

### The following OKS products are suitable for use with the Airspray-System

- OKS 370
- OKS 390
- OKS 600
- OKS 640
- OKS 700
- OKS 1510
- OKS 1600
- OKS 2610
- OKS 2650
- OKS 2660
- OKS 2670
- OKS 2800
- OKS 8600



The OKS Airspray-System on Youtube.

Further details on the application and the usage of the OKS Airspray system are provided in the **operation manual** that can be obtained in the download section of [www.oks-germany.com](http://www.oks-germany.com).

## Electromechanical lubricating systems – automatic and independent of temperature

**ChronoLube is the ideal combination of OKS speciality lubricants with an electromechanical lubricator. This enables the automatic supply of lubricating points with oil and grease. In the dosage you require and at the right time – without under- or over-lubrication.**

Simply install the ChronoLube Drive together with the suitable ChronoLube Cartridge at the lubricating point and set the dispensing time (in monthly steps) in accordance with your requirements.

Whether lubricating point that is difficult to reach, strong vibrations or extremely high ambient temperatures, OKS can provide you with the right accessories for trouble-free use of the ChronoLube-System. We will be pleased to advise in detail.

### ChronoLube, the ideal lubrication system for:

- Roller bearings
- Friction bearings
- Chains
- Open gears
- etc.

### Highlights

- Operating temperature -10 °C to +60 °C
- Continuous fill level monitoring with transparent housing
- Dispensing time can be set in monthly steps
- Dispensing duration individually adjustable when changing cartridge
- Display of operating state with LCD display (e.g. operation, empty, fault)
- Reusable drive
- Replaceable battery set

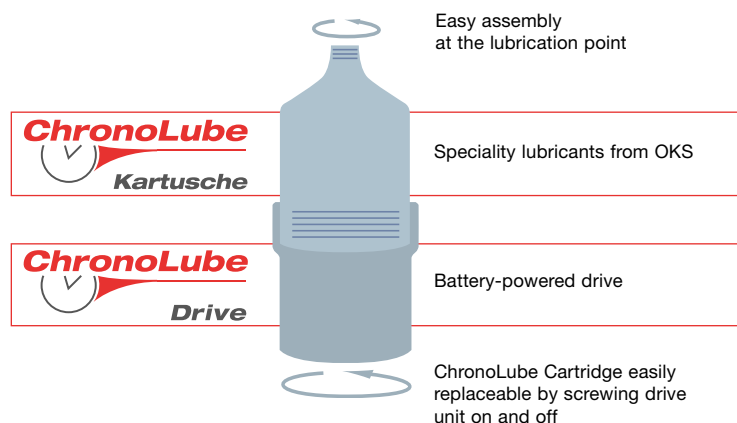

After setting the dispensing time, an additional check of the operating state takes place with the integrated LCD display.





## OKS CHRONOLUBE-SYSTEM

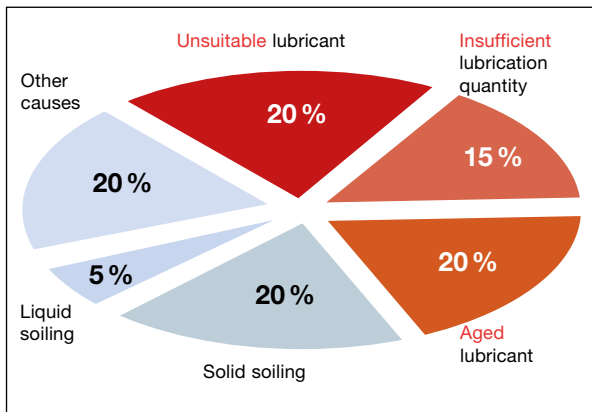

Causes of failure of roller bearings

### Avoid damage and save cost

Continuous, automatically controlled lubrication by ChronoLube mainly prevents: annoying, expensive production downtimes. Thanks to precise, individually adjusted lubricant dosage, a sudden standstill or frequent maintenance intervals due to poor lubrication are now a thing of the past.

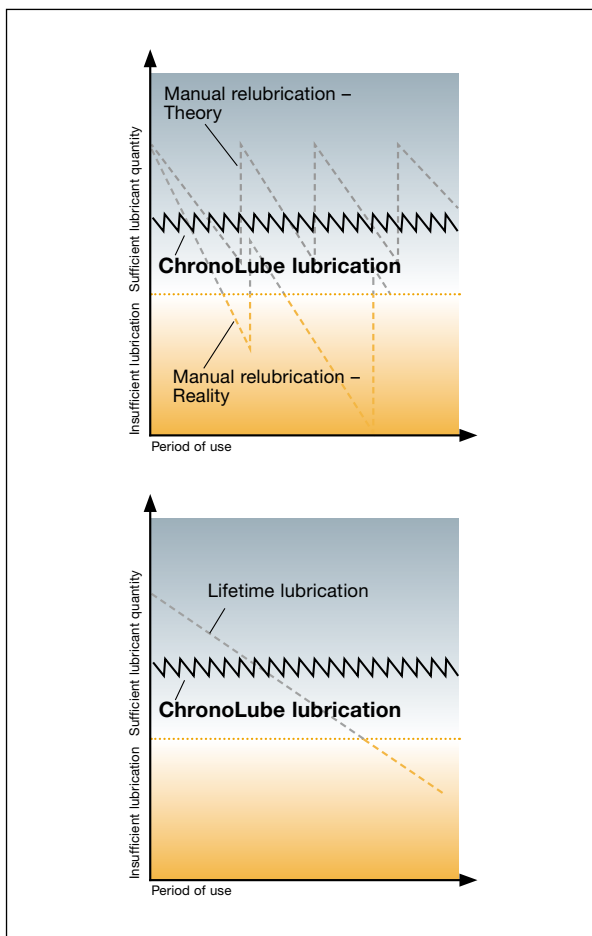

Comparison: Automatic vs. manual relubrication

### Comparison of lubrication systems

ChronoLube is highly superior to manual relubrication and lifetime lubrication with regard to precision and reliability.

**ChronoLube**  
System

The ChronoLube-System is identified by this sign.

## LUBRICATING DEVICES FOR PRACTICAL USE

### Solutions for continuous use in industry

#### Lever grease gun

The practical grease gun for reliable, economical application of greases. Thanks to its well thought-out design and rugged construction, it stands up under even the toughest conditions. Available separately or in the Lubricating Set (20 cartridges of OKS 400 including a lever grease gun).



#### Sprayboy

Together with the spray can, the sprayboy becomes the perfect spraying device. It enables simple, fatigue-free handling and exact, controlled dosing of the spray mist. (Suitable for all OKS standard spray cans with a size of 400 ml or bigger. Do not use together with Airspray can).



#### Adapter set for Reiner lever grease gun

The adapter set for the Reiner lever grease gun system for rapid and simple conversion to 400 ml DIN cartridges. Thanks to its simple mounting, all OKS product cartridges can be used with the Reiner lever grease gun without much additional effort or high additional costs.

Available as a set with 10 adapters each with threads and cartridge covers, a reducing ring and mounting instructions.



## WHAT YOU CAN EXPECT FROM OKS – PERFORMANCE THAT MOVES

# Maximum product quality, active occupational health and safety and consistent environmental protection

**These three factors form the major factors for the sustainable success of our company and our industrial and commercial customers worldwide.**

OKS is oriented towards the development, production and sales of lubricants, maintenance and corrosion protection products of the highest possible quality. Our focus lies on customers who are satisfied with our products and our performance.

All employees are committed to the high quality, environmental protection and work protection demands. Continuous personnel development results in active participation in implementing the corresponding targets.

Our high quality and environmental standards are already ingrained in our product development. Environmental protection and the user's safety have the greatest priority for us. Not only through our environmentally conscious company management, but in particular through the development of state-of-the-art lubricants do we contribute to a marked reduction of the negative environmental impact caused by technical factors.

We utilise modern production processes in manufacturing our products. In safe and environmentally friendly production processes we keep the effect on man and environment as small as possible.

In cooperation with our local sales partners we place great emphasis on qualification and thus ensure excellent consulting services and competence in solving problems locally.

Our participation in the initiative "We all take care", an initiative of the Freudenberg Group for environmental and work protection and for the reduction of occupational accidents, is further proof that our goals are corporate practice.

The high OKS quality standard is proven by our certification by the TÜV SÜD Management Service GmbH in the fields of quality (ISO 9001:2008), environment (ISO 14001:2004) and work protection (OHSAS 18001:2007).

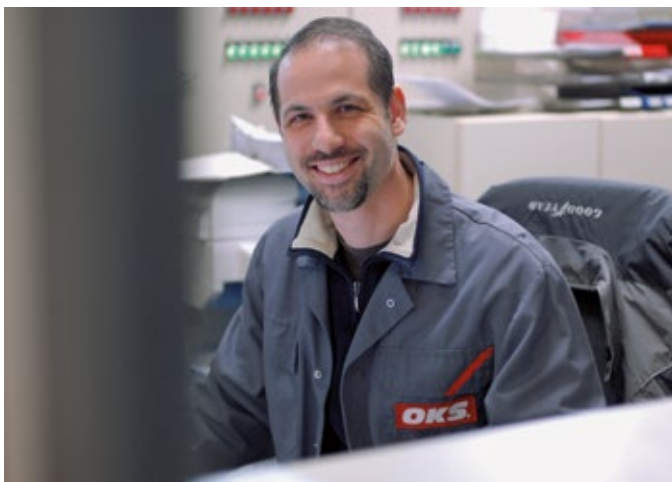



www.oks-germany.com

## Over 150 high-performance products from one supplier



- **Pastes** for easy assembly and dismantling
- **Oils** with high-performance additives for reliable lubrication
- **Greases** for long-term lubrication under critical operation conditions
- **Dry lubricants** – the alternative for special application cases
- **Corrosion protection** for reliable preservation during storage and shipping
- **Maintenance products** for ongoing service
- **Cleaners** for thorough removal of soiling and lubricant residues

For your company's individual lubrication requirements please contact OKS.

The world of OKS Speciality Lubricants in one APP



Download on:  
[www.oks-germany.com](http://www.oks-germany.com)

## CONSULTING AND SALES

The information in this publication reflect state-of-the-art technology, as well as extensive testing and experience. Due to the diversity of possible applications and technical realities, they can only serve as recommendations and are not arbitrarily transferable. Therefore, no obligations, liability or warranty claims can be derived from them. We only accept liability for the suitability of our products for particular purposes, and for certain properties of our products, in the event that we have accepted such liability in writing in the individual case. Any case of justified warranty claims shall be limited to the delivery of replacement goods free of defects or, in the event that this subsequent improvement fails, to reimbursement of the purchase price. Any and all further claims, in particular the liability for consequential injuries or damage, shall always be excluded. **Prior to use, the customer must conduct its own testing to prove suitability.** No liability accepted for spelling mistakes, typing errors, miscalculations and translation errors. The data are subject to change for the sake of progress. © = registered trademark

**OKS Spezialschmierstoffe GmbH**  
Ganghoferstr. 47  
D-82216 Maisach  
Phone +49 (0) 8142 3051-500  
[info@oks-germany.com](mailto:info@oks-germany.com)

a brand of  
 **FREUDENBERG**

For a world in motion

1137120000 1706 En 4 6 1 7  
Concept: www.k1a-marketing.de  
Realisation: OKS Spezialschmierstoffe GmbH